

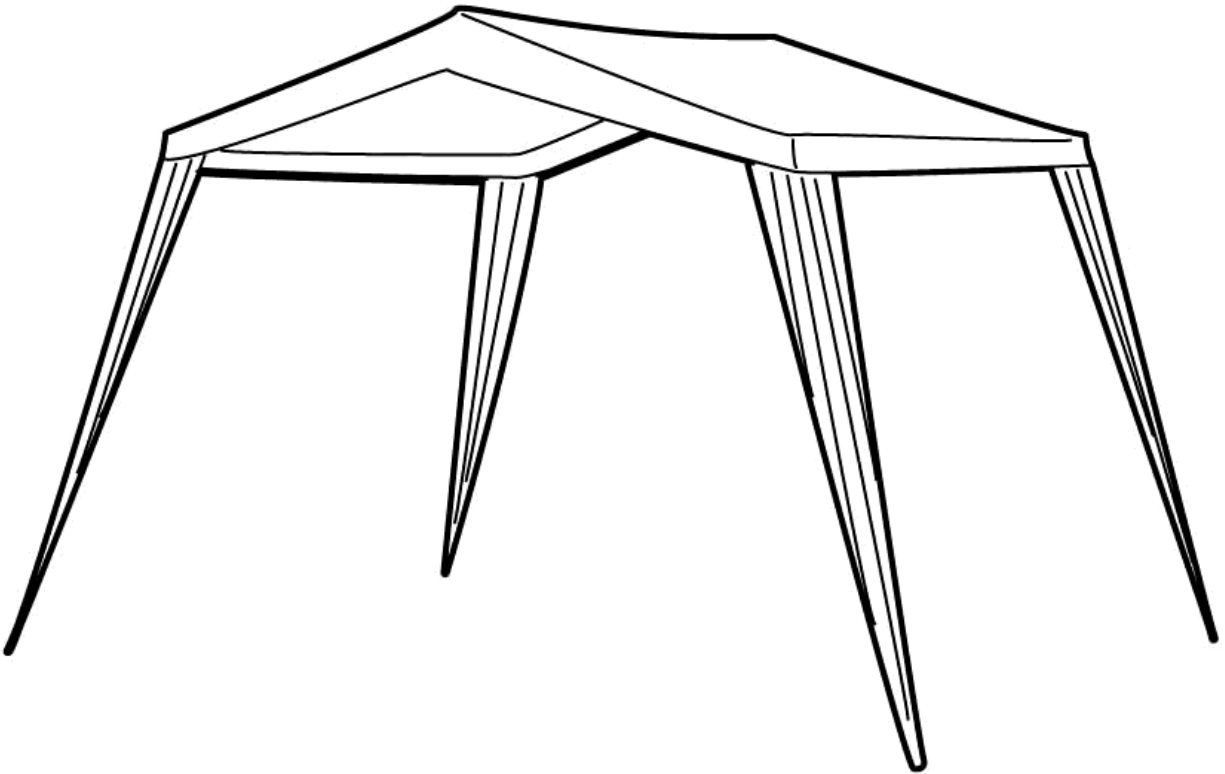















fourstargroup



MODEL : 12502708
SUN SHELTER 8' X 11'

PARTS LIST AND HARDWARE

A. FRAME #1 (3 PCS)	
B. FRAME #2 (6 PCS)	
C. FRAME #3A (4 PCS)	
D. FRAME #3B (4 PCS)	
E. LEG FRAME #4 (4 PCS)	
F. LEG FRAME #5 (4 PCS)	
G. LEG FRAME #6 (4 PCS)	
H. CORNER CONNECTOR #R (2 PCS)	
I. CORNER CONNECTOR #L (2 PCS)	
J. BEAM CONNECTOR #T (2 PCS)	
K. PLATES (4 PCS)	
L. STAKES (8 PCS)	
M. ROPE (4 PCS)	
N. PAVILION COVER (1 PC)	

ASSEMBLY INSTRUCTIONS

NOTED:

1. PLEASE CHECK THE PARTS INSIDE THE PACKAGE CAREFULLY, IF PARTS ARE MISSING OR BROKEN, CONTACT CUSTOMER SERVICE USING THE INFORMATION AT THE BACK OF THIS MANUAL.

2. ASSEMBLY REQUIRES 2 PEOPLE.

Step 1:

ASSEMBLE ROOF FRAME:

Insert metal tube FRAMES #1, 2, 3A & 3B (A/B/C/D) into CORNER CONNECTORS #R & L (H/I) and BEAM CONNECTORS #T (J). Please refer to Fig 1 to assemble metal tube numbers.

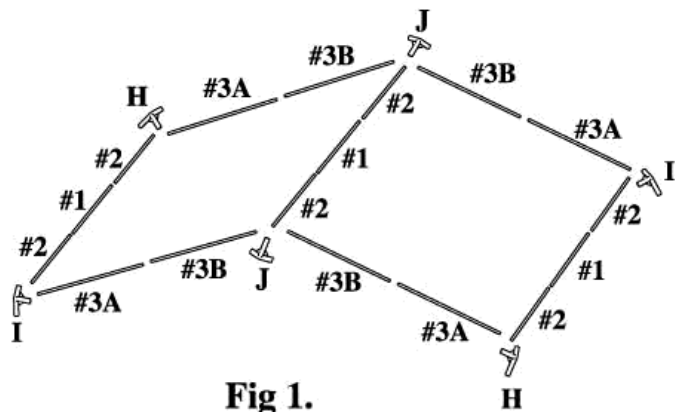

Fig 1.

Step 2:

ASSEMBLE GAZEBO

COVER: Pull the COVER (N) tightly over the assembled roof frame, see Fig 2.

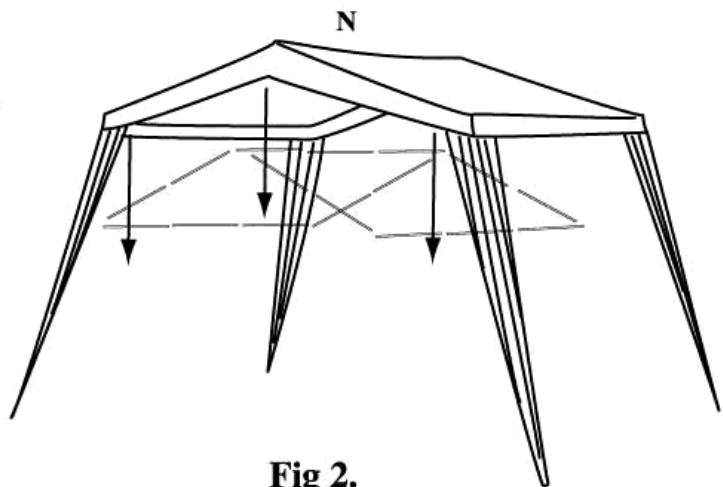
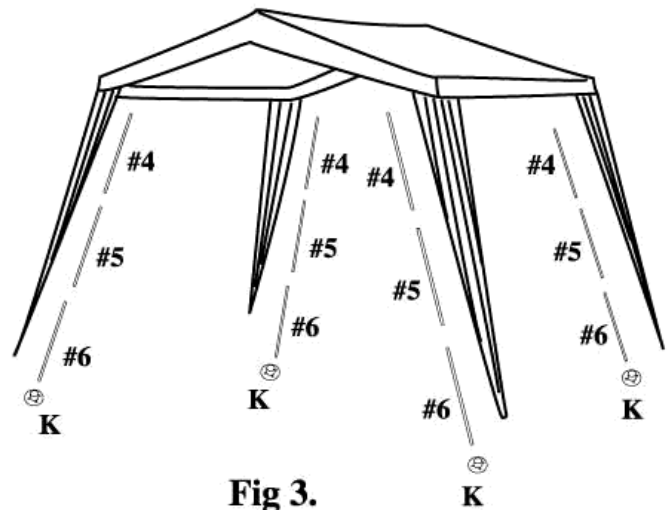

Fig 2.

Step 3:

LEG ASSEMBLY: Lift up the **CORNER CONNECTOR #R & L (H/I)** and insert the **LEG FRAME TUBE 4, 5 & 6 (E/F/G)**. Place **PLATE (K)** to bottom tubes. Repeat until all 4 legs are fully assembled, as shown in Fig 3.



Step 4:

SET - UP GAZEBO: Pull the cover tightly over the assembled frames. Insert the hook on the top of cover corners, lift - up and move gazebo to desired place. Adjust 4 legs and sticks with 2 **STAKES (L)** of each leg. Tighten the cover by fastening **ROPE (M)** to hook and stake. Repeat until all 4 corners are tight. Fasten velcro tabs of cover to metal frame. Please check to make sure they are properly secured. Please see fully assembled gazebo in Fig 4.

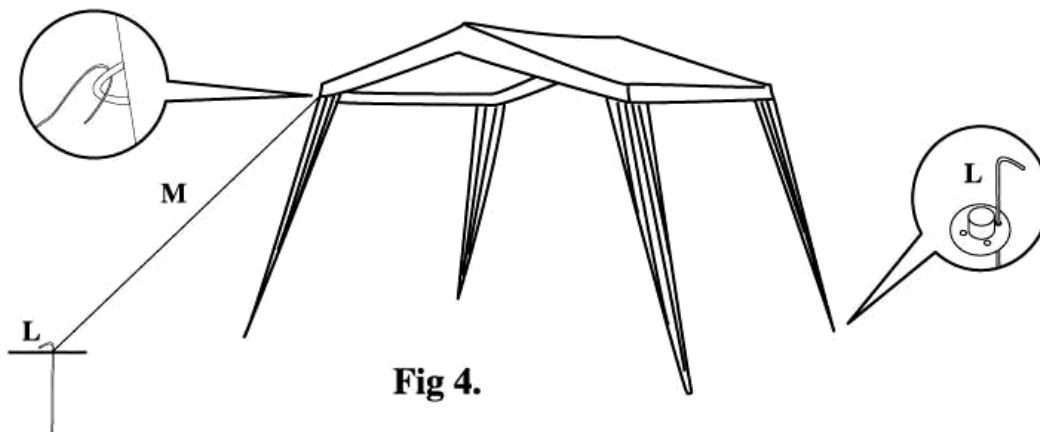

Do you have any questions ? Missing small parts or hardware ?
If you need assistance with the assembly of your SUN SHELTER
8' X 11' please e-mail our Customer Service Department at:
support@fourstari.com
or call us at (508) 435-4830
or (800) 639-3803

Please include the following information in your email:

- Where item was purchased
- Item, model, style or SKU number listed on instructions or box
- Part number, description of the part and quantity needed

This information will help us get the proper part to you faster

