

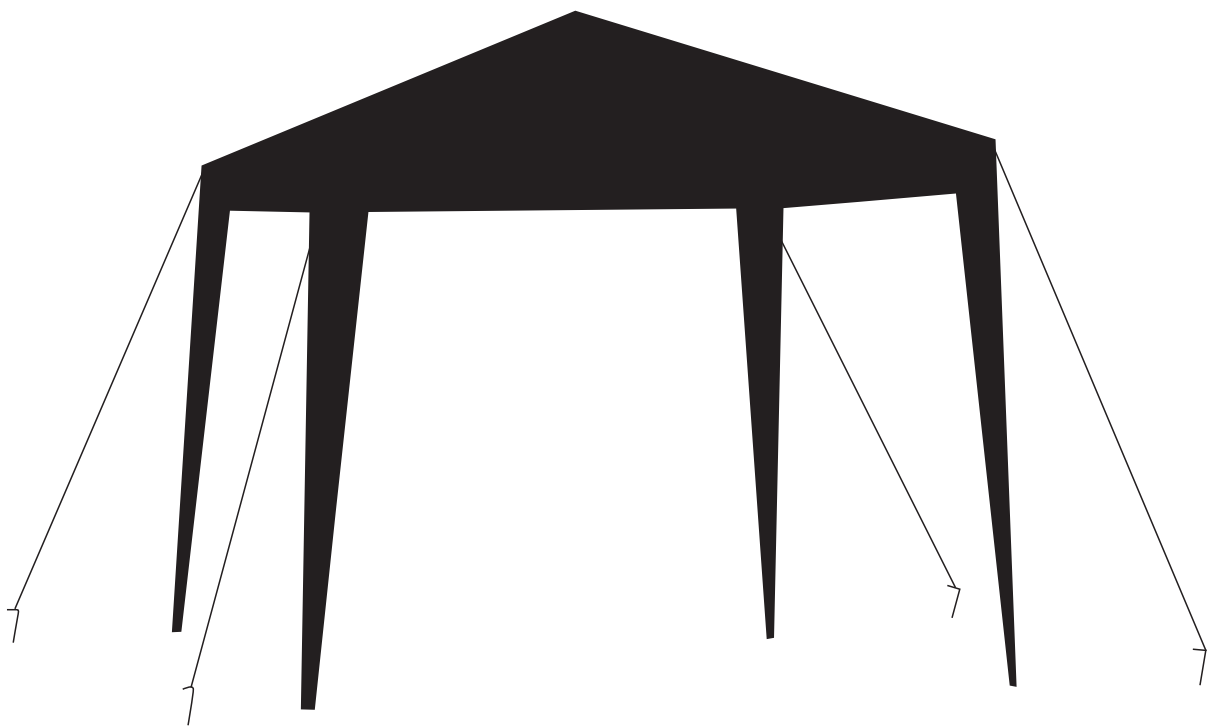

fourstargroup



MODEL: 12504362V

10 ft. x 10 ft. GAZEBO







⚠ WARNING:

1. Keep all flame and heat sources away from this gazebo fabric. This gazebo is made with fabric that meets CPAI-84 specifications for flame resistance. It is not fire proof. The fabric will burn with continuous contact with any flame source.
2. Don't place any other material on the face side of canopy
3. Don't load weight on the steel tube of the eave.
4. This is a sun shelter. It should not be used while there is heavy rain or strong wind.

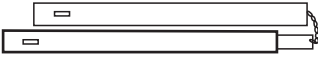
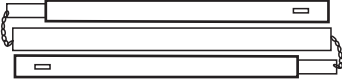
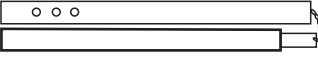
PARTS LIST

PRECAUTIONS:

1. CHECK ALL PARTS AND HARDWARE LISTED ON THE PARTS LIST. LAY THEM ON A CLEAR AND LEVEL SURFACE PRIOR TO ASSEMBLY.
2. IT IS RECOMMENDED TO HAVE 2 PEOPLE FOR ASSEMBLY.

NO	HARDWARE LIST	QTY
1	TUBE NO.1 	4PCS
2	TUBE NO.2 	4PCS
3	TUBE NO.3 	4PCS
A	VERTEX CONNECTOR 	1PC
B	PLASTIC BASE 	4PCS
C	CORNER CONNECTOR 	4PCS
D	ROPE 	4PCS
E	STEEL STAKE 	8PCS

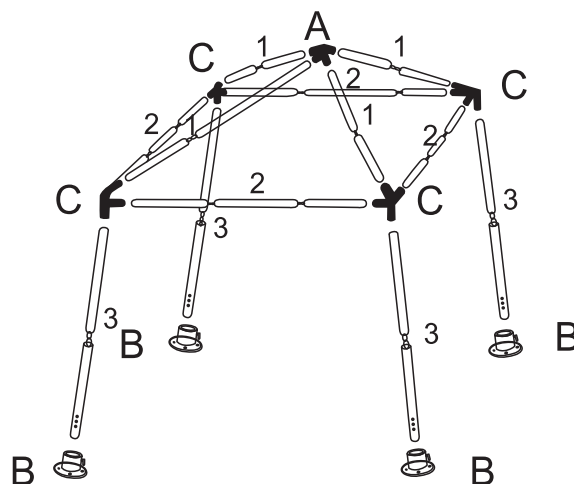

ASSEMBLY INSTRUCTIONS

BEFORE YOU BEGIN, PLEASE READ ASSEMBLY INSTRUCTIONS THOROUGHLY. FOLLOW THEM STEP BY STEP.

STEP 1: UPPER FRAME ASSEMBLY

CONNECT POLES NO. 2 TO BE A WHOLE BAR, CONNECT THE BARS TO THE CORNER CONNECTOR (C) MAKING SURE TO CLICK INTO PLACE TO FORM A SQUARE TOP FRAME AS SHOW IN FIG. 1.

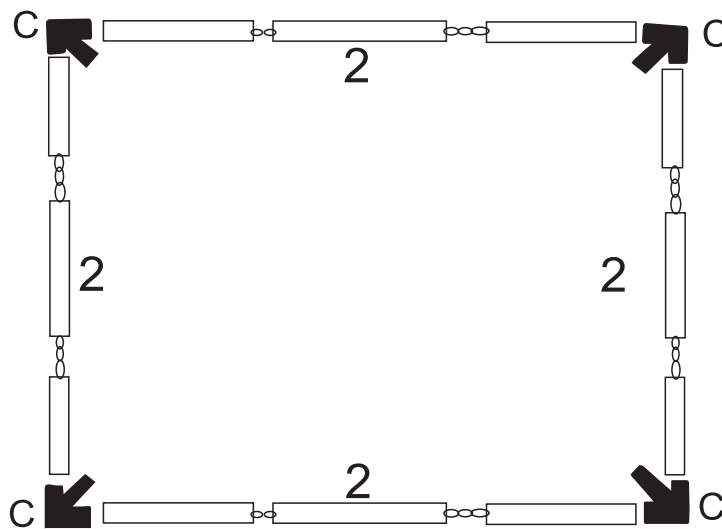

Fig. 1

STEP 2: TOP FRAME ASSEMBLY

CONNECT POLES NO.1 TO BE A WHOLE BAR, SLIDE ONE END OF TUBE NO. 1 INTO THE VERTEX CONNECTOR (A) LOCKING INTO PLACE. SLIDE THE OTHER END OF TUBE NO. 1 INTO THE CORNER CONNECTOR (C) UNTIL IT LOCKS INTO PLACE. CONNECT TUBE NO. 3 INTO THE CORNER CONNECTOR (C). BUT NOT CONNECT TUBE NO. 3 TO BE A WHOLE BAR AS SHOW IN FIG 2.

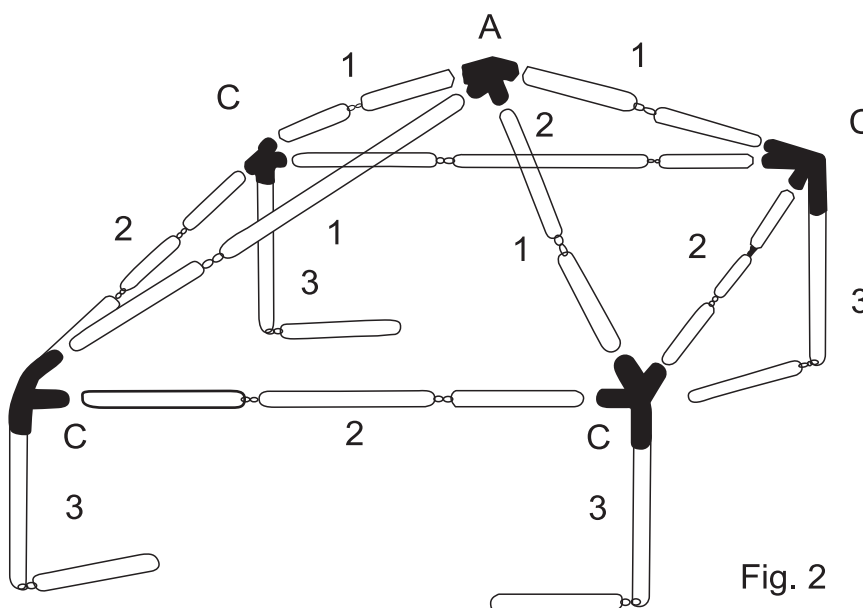

Fig. 2

**STEP 3: PULL THE CANOPY TIGHTLY OVER THE FRAME AS SHOWN IN FIG. 3.
 BOTTOM FRAME ASSEMBLY: CONNECT TUBE NO. 3 TO BE A WHOLE BAR.
 SLIDE THE PLASTIC BASE (B) ONTO THE END OF TUBE NO. 3 AS SHOWN IN FIG. 3.**

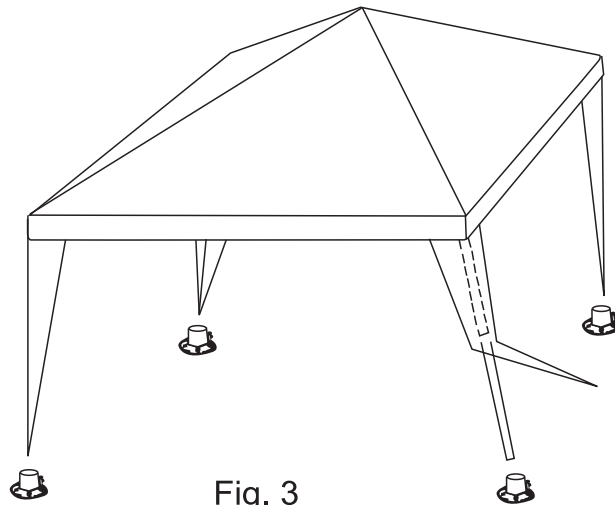

Fig. 3

STEP 4: FINAL ASSEMBLY

ONCE THE LEGS ARE IN POSITION, ATTACH EACH LEG FLAP OF THE CANOPY ON TO TUBE NO. 3 WITH THE METAL HOOKS. SLIDE THE D RING AT THE END OF EACH LEG FLAP OF THE CANOPY OVER THE MOLDED HOOK ON EACH PLASTIC BASE (B). IF THE CANOPY BECOMES LOOSE DURING USE, REPOSITION THE METAL HOOK INTO THE NEXT HOLE DOWN UNTIL PROPER TENSION HAS BEEN ACHIEVED. SECURE THE GAZEBO TO THE GROUND USING THE STEEL STAKES (E) AND ROPES (D) PROVIDED (4 STAKES FOR 4 ROPES AND 4 STAKES ON 4 PLASTIC BASE (B)). (STAKES SHOULD BE DRIVEN INTO THE GROUND AT AN ANGLE AS SHOWN IN FIG. 4 TO MAXIMIZE SECURE TENSION.)

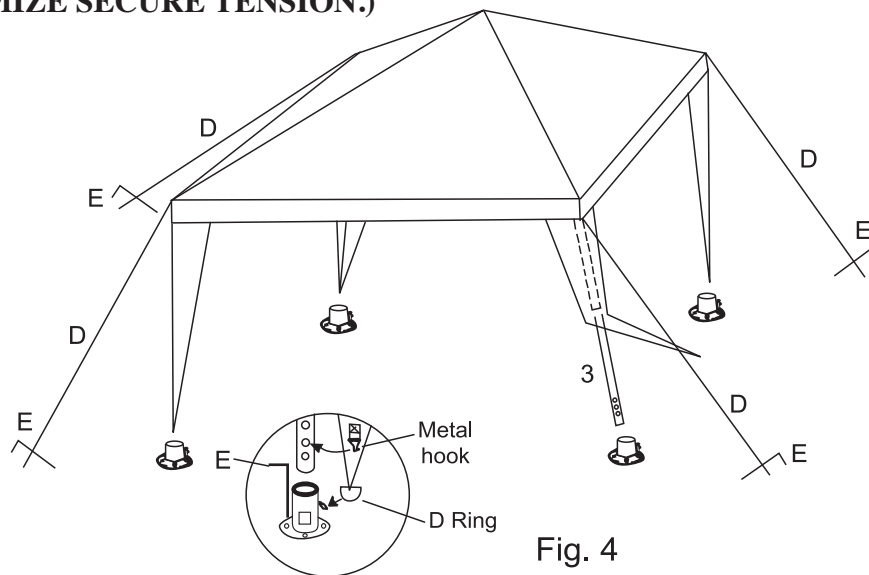

Fig. 4

Do you have any questions? Missing small parts or hardware?
 If you need assistance with the assembly of your 10 ft. x 10 ft.
 GAZEBO please e-mail our Customer Service Department at:
support@fourstari.com
 or call us at **(508) 435-4830**
 or (800) 639-3803

Please include the following information in your email:

- Where item was purchased
- Item, model, style or SKU number listed on instructions or box
- Part number, description of the part and quantity needed

This information will help us get the proper part to you faster