





















fourstargroup

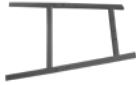

MODEL: 12504050

3 PIECE BAR SET

PARTS LIST AND HARDWARE

NO	HARDWARE LIST	QTY
A	TABLE FRAME 	1 PC
B	SIDE PANEL 	2 PCS
C	WEB SHELF 	1 PC
D	FRONT PANEL 	1 PC
E	CANOPY POLE 	2 PCS
F	CANOPY SIDE FRAME 	2 PCS
G	CANOPY MAIN FRAME 	2 PCS
H	CANOPY ROOF FRAME 	1 PC
I	GLASS TABLE TOP 	1 PC
J	CANOPY 	1 PC
K	CHAIR SEAT 	2 PCS
L	CHAIR LEG 	4 PCS
M	CHAIR UPPER TUBE 	2 PCS
N	CHAIR BOTTOM TUBE 	4 PCS
O	KNOB KIT 	2 PCS
P	LONG BOLT (45MM) WITH WASHER 	4 PCS
Q	MEDIUM BOLT (30MM) WITH WASHER 	16 PCS
R	SHORT BOLT (15MM) WITH WASHER 	32 PCS
S	PLASTIC CAP 	52 PCS
T	ALLEN WRENCH 	2 PCS

ASSEMBLY INSTRUCTIONS

PRECAUTIONS:

1. THE CARTON CONTAINS GLASS TABLE TOP.
PLEASE UNPACK THE CARTON CAREFULLY.
2. IT IS RECOMMENDED TO HAVE 2 PEOPLE FOR ASSEMBLY.
3. PLEASE CHECK THE PARTS AND HARDWARE CAREFULLY TO
MAKE SURE THERE ARE NO MISSING PARTS.

ASSEMBLY FOR BAR TABLE

STEP 1

CONNECT THE TABLE
FRAME (A) TO SIDE
PANEL (B) WITH LONG
BOLT (P). SEE FIG. 1

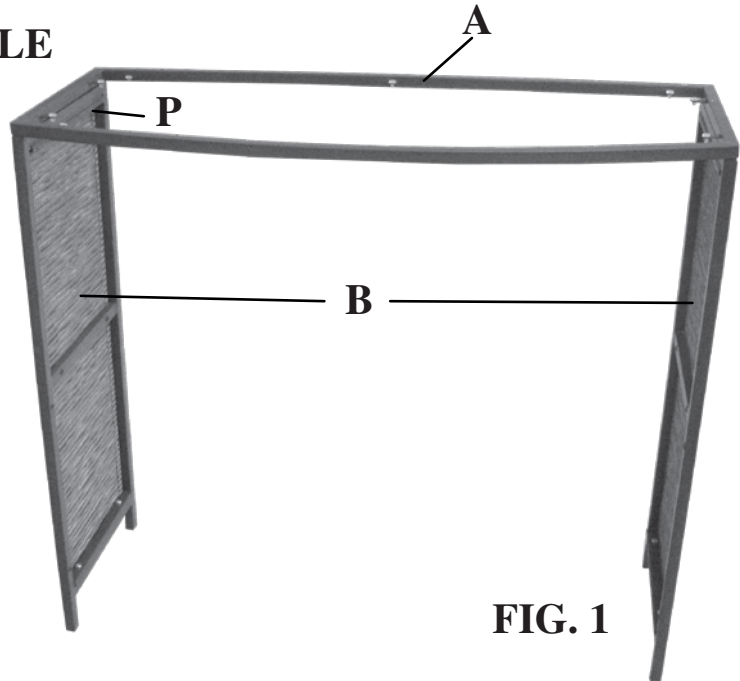

FIG. 1

STEP 2

ATTACHED THE WEB SHELF (C)
TO BOTH SIDE PANEL (B) WITH
SHORT BOLT (R). SEE FIG. 2

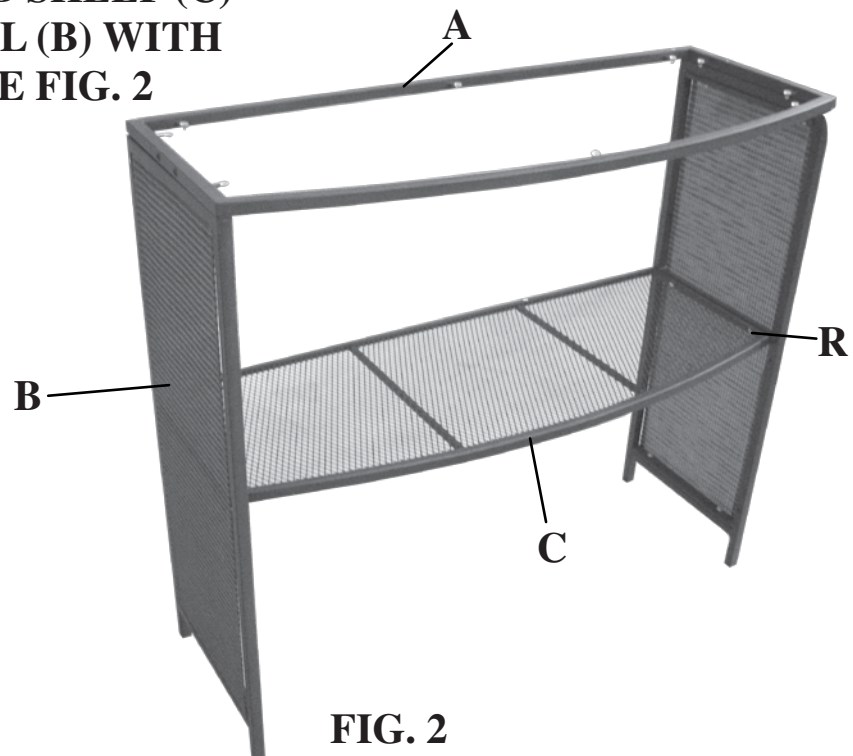

FIG. 2

STEP 3

POSITION THE FRONT PANEL (D) TO BOTH SIDE PANELS (B) WITH MEDIUM BOLT (Q) GET THE MEDIUM BOLT (Q) THROUGH THE STEEL BAR, THEN CONNECT THE STEEL BAR TO THE TABLE FRAME (A). SEE FIG. 3

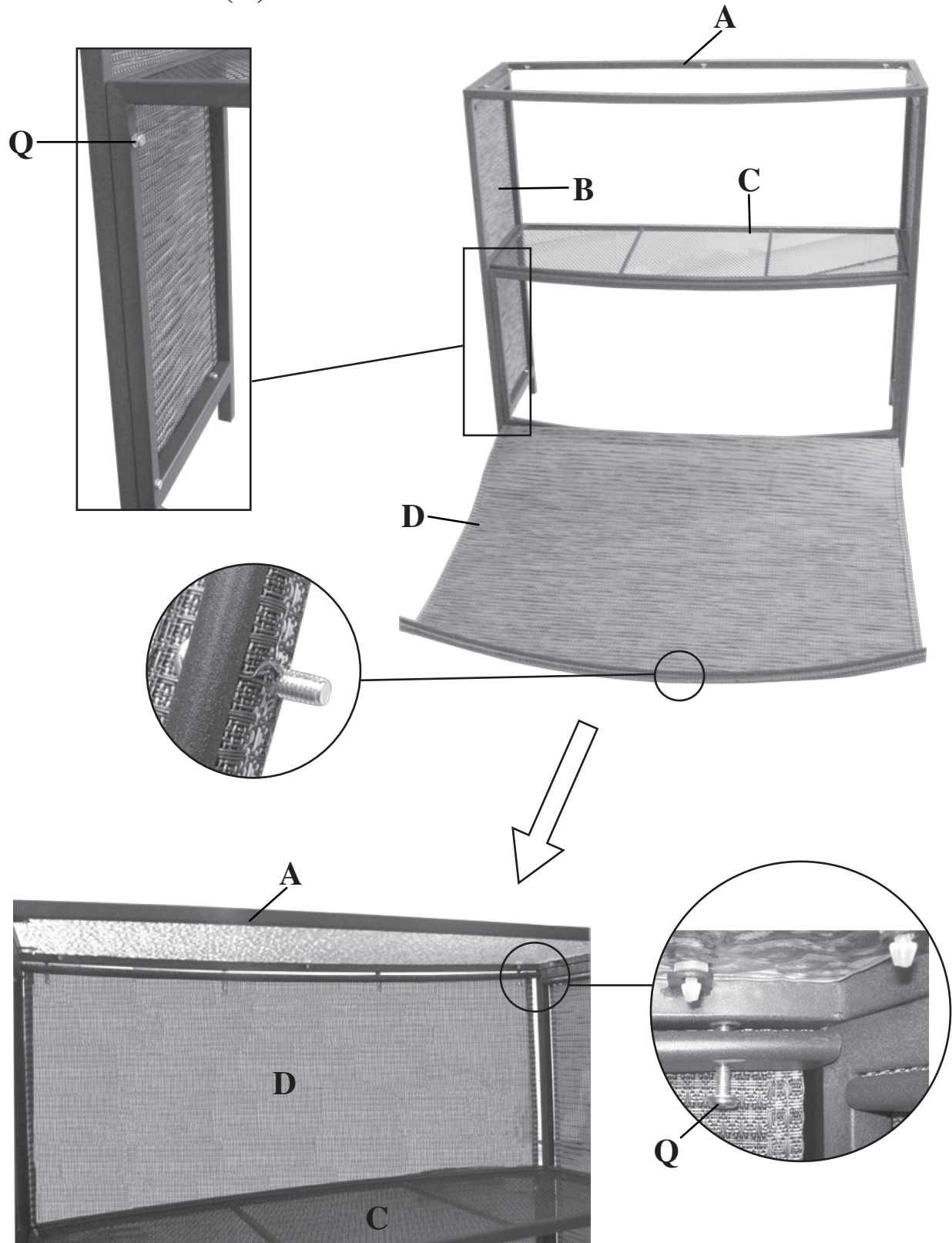

FIG. 3

STEP 4

PLACE THE GLASS TABLE TOP (I) INTO THE TABLE FRAME (A). THEN CONNECT THE CANOPY POLE (E) TO TABLE FRAME (A) WITH SHORT BOLT (R). JOIN CANOPY ROOF FRAME (H) TO CANOPY POLE (E). SEE FIG. 4

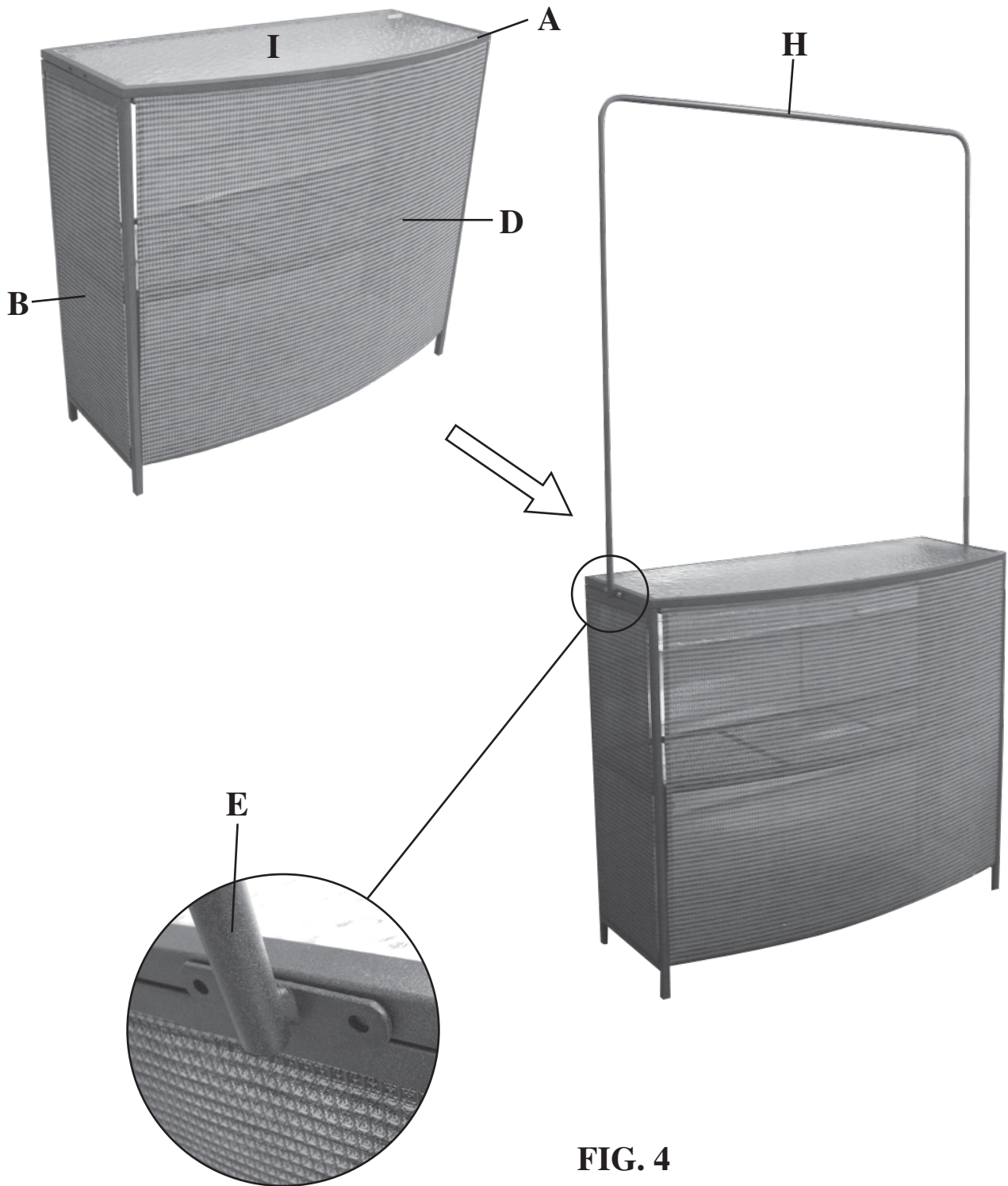

FIG. 4

STEP 5
ASSEMBLE THE CANOPY AS SHOWN BELOW.

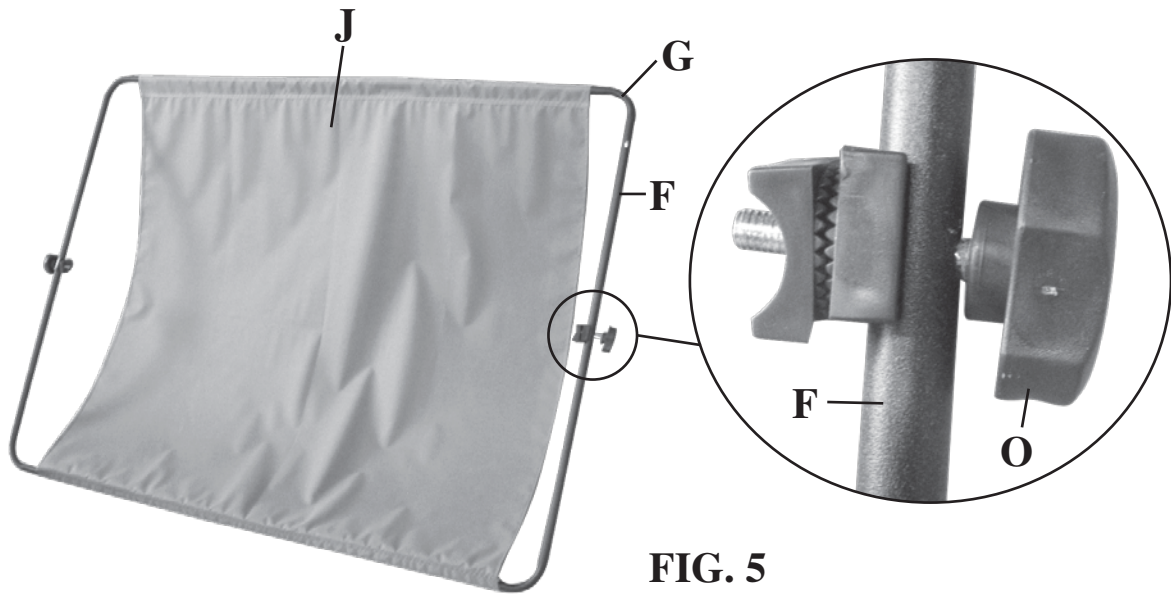
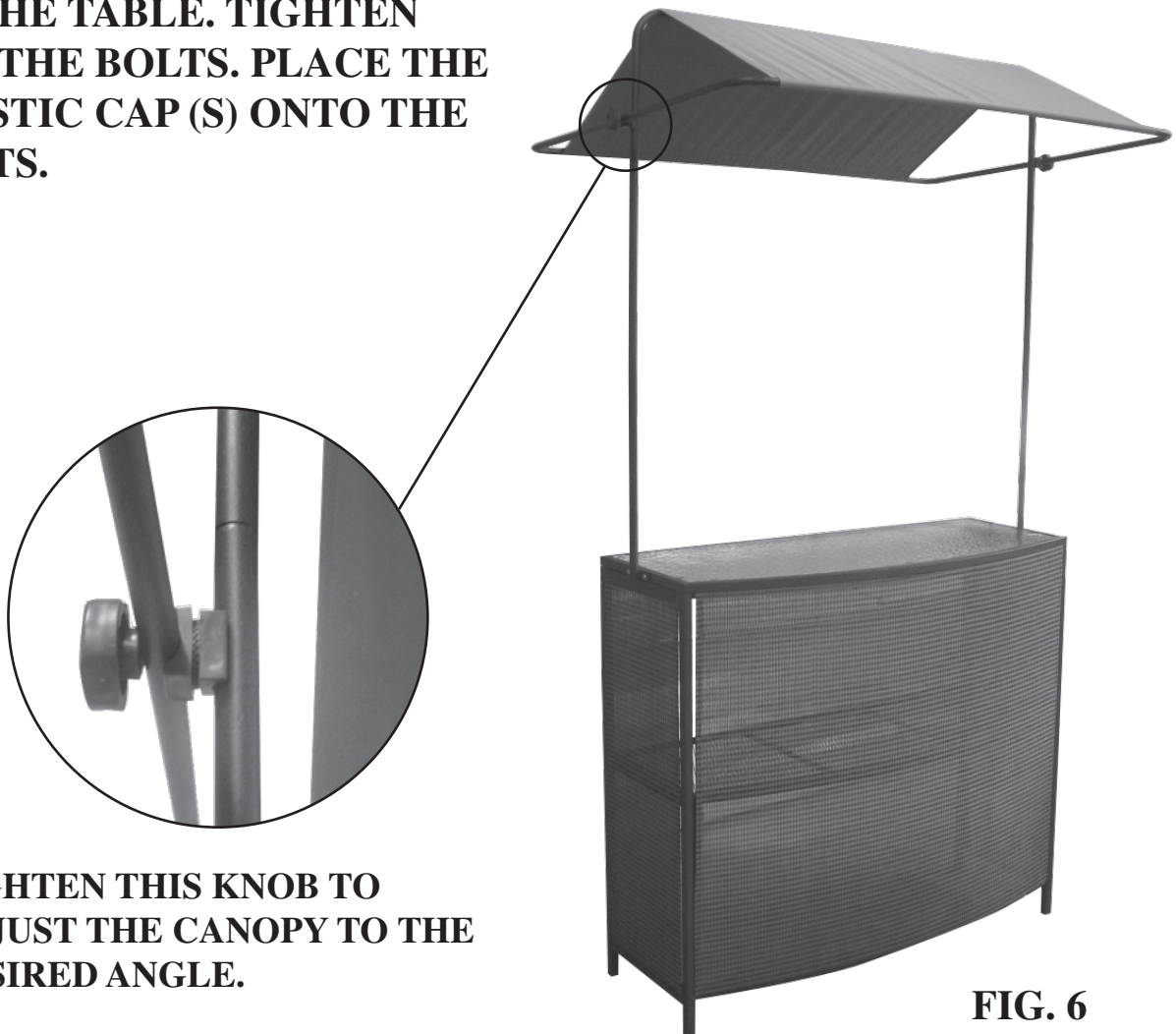

FIG. 5

STEP 6
PLACE THE CANOPY ON TOP
OF THE TABLE. TIGHTEN
ALL THE BOLTS. PLACE THE
PLASTIC CAP (S) ONTO THE
BOLTS.



TIGHTEN THIS KNOB TO
ADJUST THE CANOPY TO THE
DESIRED ANGLE.

FIG. 6

ASSEMBLY FOR BAR CHAIR

STEP 1

CONNECT CHAIR UPPER TUBE (M) AND CHAIR BOTTOM TUBE (N) TO CHAIR LEG (L) WITH SHORT BOLT (R).

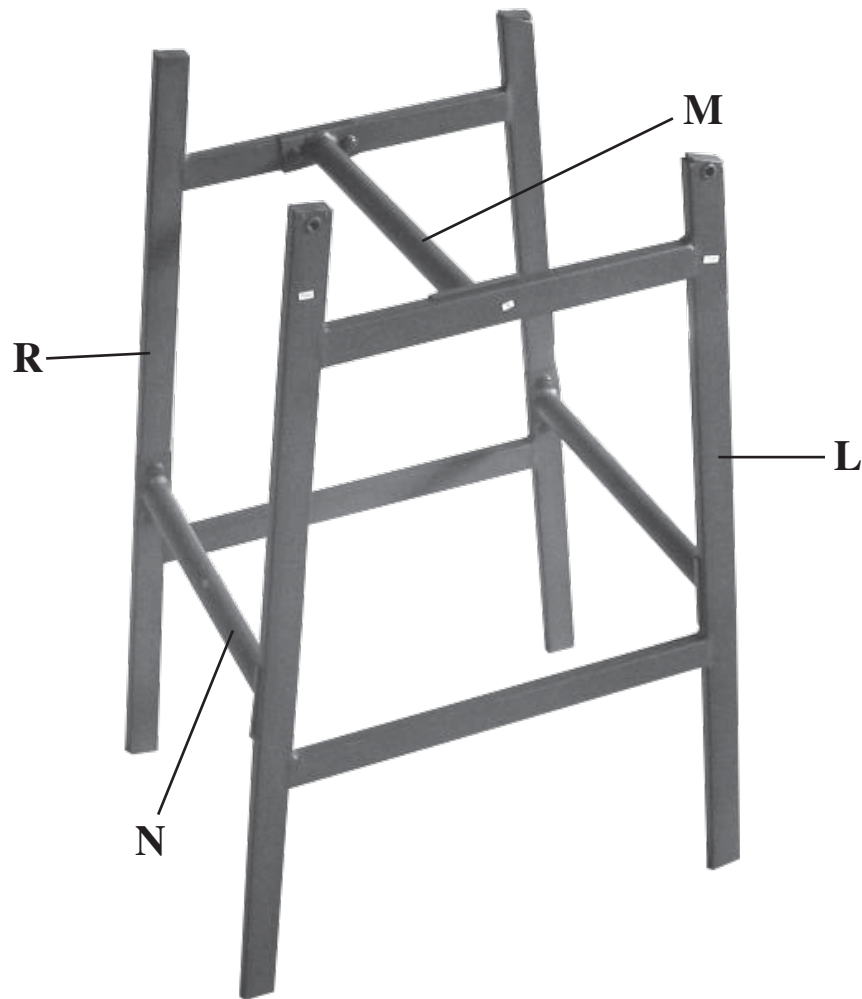

FIG. 1

STEP 2

PLACE CHAIR SEAT (K) INTO POSITION WITH MEDIUM BOLT (Q). MAKE SURE TO ATTACH IT AS PER THE FRONT AND REAR MARKING, SHOWN ON THE CHAIR LEG (L).

PLACE ALL PLASTIC CAP (S) ONTO ALL BOLTS.

THE ASSEMBLY OF THE BAR CHAIR IS FINISHED.

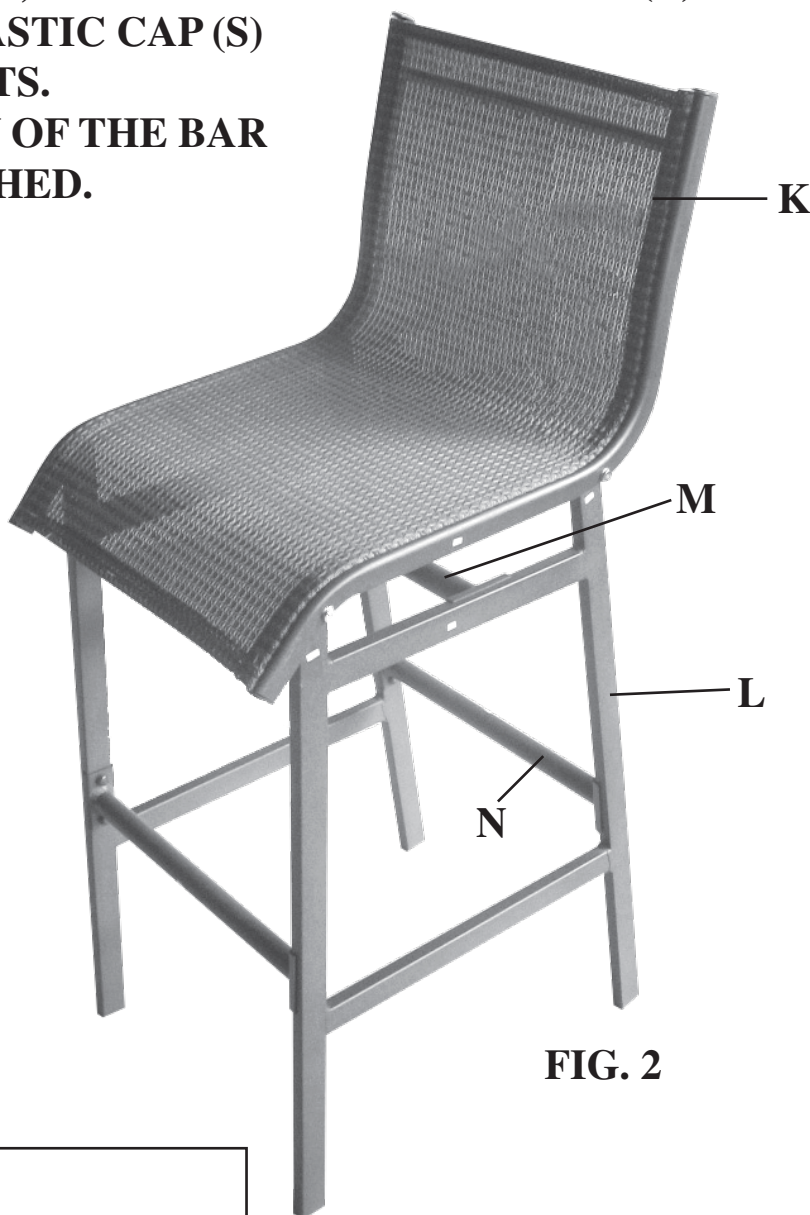

FIG. 2



WARNING:

The items in this set have small parts including plastic caps which may fall off and become choking hazards for children under three. Children should be supervised carefully when they are near this furniture.

Do you have any questions? Missing small parts or hardware?

If you need assistance with the assembly of your 3 PIECE BAR SET please e-mail our Customer Service Department at:

support@fourstari.com

or call us at (508) 435-4830

or (800) 639-3803

Please include the following information in your email:

- Where item was purchased
- Item, model, style or SKU number listed on instructions or box
- Part number, description of the part and quantity needed

This information will help us get the proper part to you faster