

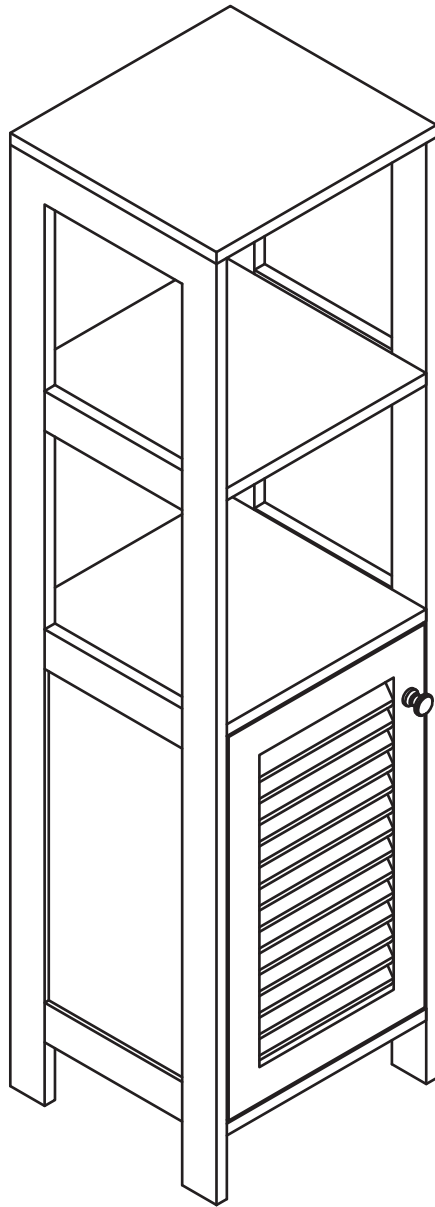

fourstargroup







**MODEL: 11225674 / MODELO: 11225674**





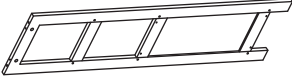
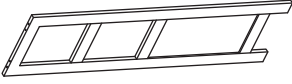
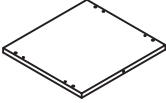
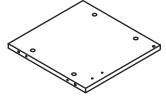
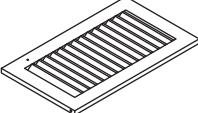
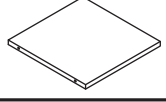
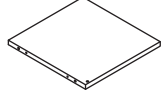
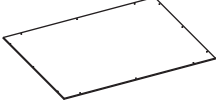
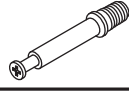
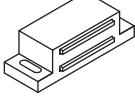





**BATHROOM CABINET**

**MUEBLE DE BAÑO**

# PARTS AND HARDWARE

## LISTA DE PARTES Y HARDWARE

NO	HARDWARE LIST LISTA DE HARDWARE	QTY CNT
A	<b>RIGHT FRAME</b> <b>MARCO DERECHO</b> 	<b>1 PC</b> <b>1 PZ</b>
B	<b>LEFT FRAME</b> <b>MARCO IZQUIERDO</b> 	<b>1 PC</b> <b>1 PZ</b>
C	<b>TOP PANEL</b> <b>PANEL SUPERIOR</b> 	<b>1 PC</b> <b>1 PZ</b>
D	<b>MIDDLE SHELF</b> <b>PLATAFORMA MEDIA</b> 	<b>1 PC</b> <b>1 PZ</b>
E	<b>DOOR</b> <b>PUERTAS</b> 	<b>1 PC</b> <b>1 PZ</b>
F	<b>UPPER SHELF</b> <b>ESTANTE SUPERIOR</b> 	<b>1 PC</b> <b>1 PZ</b>
G	<b>BOTTOM SHELF</b> <b>ESTANTE INFERIOR</b> 	<b>1 PC</b> <b>1 PZ</b>
H	<b>BACK BOARD</b> <b>PANEL TRASERO</b> 	<b>1 PC</b> <b>1 PZ</b>
①	<b>CAM LOCK SCREW</b> <b>TORNILLO DE LEVA</b> 	<b>12 PCS</b> <b>12 PZS</b>
②	<b>MAGNET</b> <b>IMAN</b> 	<b>1 PC</b> <b>1 PZ</b>
③	<b>16MM SCREW</b> <b>16MM TORNILLO</b> 	<b>2 PCS</b> <b>2 PZS</b>
④	<b>WOOD DOWEL</b> <b>CLAVIJA DE MADERA</b> 	<b>16 PCS</b> <b>16 PZS</b>
⑤	<b>CAM LOCK NUT</b> <b>TUERCA DE LEVA</b> 	<b>12 PCS</b> <b>12 PZS</b>

NO	<b>HARDWARE LIST</b> <b>LISTA DE HARDWARE</b>	<b>QTY</b> <b>CNT</b>
⑥	<b>SUPPORT HARDWARE</b> <b>SOPORTE</b>	 <b>2 PCS</b> <b>2 PZS</b>
⑦	<b>MAGNET PLATE</b> <b>PLACA DE METAL</b>	 <b>1 PC</b> <b>1 PZ</b>
⑧	<b>11MM SCREW</b> <b>11MM TORNILLO</b>	 <b>1 PC</b> <b>1 PZ</b>
⑨	<b>24MM SCREW</b> <b>24MM TORNILLO</b>	 <b>1 PC</b> <b>1 PZ</b>
⑩	<b>HANDLE</b> <b>MANIJA</b>	 <b>1 PC</b> <b>1 PZ</b>
⑪	<b>11MM SCREW WITH SPACER</b> <b>TORNILLO DE 11 MM CON SEPARADOR</b>	 <b>14 PCS</b> <b>14 PZS</b>
⑫	<b>PLASTIC NUT</b> <b>TUERCA PLÁSTICA</b>	 <b>1 PC</b> <b>1 PZ</b>
⑬	<b>32MM LARGE SCREW</b> <b>32MM TORNILLO GRANDE</b>	 <b>1 PC</b> <b>1 PZ</b>
⑭	<b>L - BRACKET</b> <b>1PC SOPORTE -L-</b>	 <b>1 PC</b> <b>1 PZ</b>
⑮	<b>11MM SCREW</b> <b>11MM TORNILLO</b>	 <b>1 PC</b> <b>1 PZ</b>

# ASSEMBLY INSTRUCTIONS

## INSTRUCCIONES DE ENSAMBLAJE

### CAUTION:

1. ENSURE YOU HAVE ALL THE PARTS AND HARDWARE LISTED BEFORE ASSEMBLING THE BATHROOM CABINET
2. ASSEMBLE ON A SOFT SURFACE TO PREVENT DAMAGING THE PRODUCT'S FINISH.

### PRECAUCIÓN:

1. ASEGÚRESE DE QUE TIENE TODAS LAS PIEZAS Y ACCESORIOS ENUMERADOS ANTES DE MONTAR EL MUEBLE DE BAÑO
2. MONTAR EN UNA SUPERFICIE LISA PARA EVITAR DAÑAR EL ACABADO DEL PRODUCTO.

**ASSEMBLY TOOL REQUIRED: PHILLIPS SCREWDRIVER.**

**HERRAMIENTA NECESARIA PARA EL MONTAJE:  
DESTORNILLADOR PHILLIPS .**

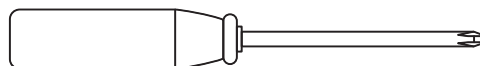

### STEP 1

ATTACH CAM LOCK SCREWS ① INTO LEFT & RIGHT FRAME (A,B) AND TOP PANEL & MIDDLE SHELF(C,D). ATTACH FIT PART ⑭ ONTO TOP PANEL(C) USE 11MM SCREW ⑮. ATTACH MAGNET ② ONTO MIDDLE SHELF(D). USE 16MM SCREWS ③ AS SHOWN.

### PASO 1

COLOQUE LOS TORNILLOS DE BLOQUEO DE LEVA ① EN EL MARCO IZQUIERDO Y DERECHO (A, B); EL PANEL SUPERIOR Y ESTANTE INTERMEDIO (C, D). ADJUNTE EL SOPORTE L ⑭ SOBRE EL PANEL SUPERIOR (C) USANDO 11MM TORNILLO ⑮ . ADJUNTAR EL IMÁN ② A LOS ESTANTES MEDIOS (D) . UTILIZANDO TORNILLOS DE 16 MM ③ COMO SE MUESTRA.

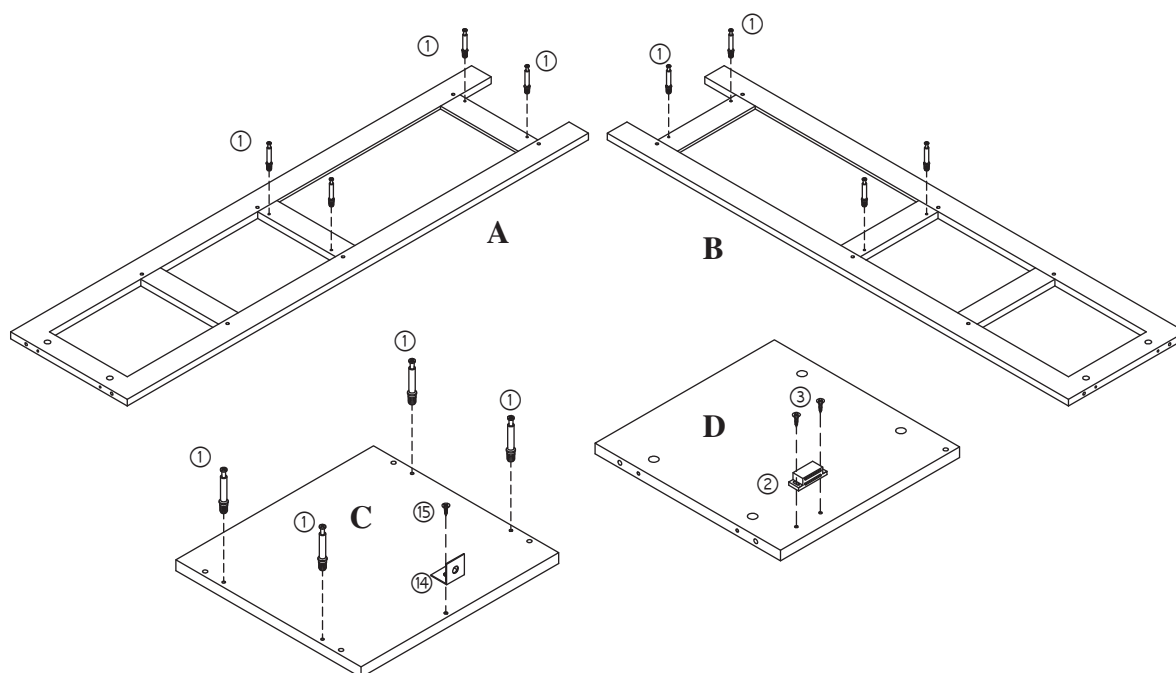

## STEP 2

ATTACH MAGNET PLATE ⑦ ONTO DOOR(E). ATTACH HANDLE ⑩ ONTO DOOR(E) USE 24MM SCREW ⑨. ATTACH DOOR(E) BETWEEN MIDDLE & BOTTOM SHELF(D,G). THEN ATTACH (D,G) ONTO LEFT FRAME(B) USE WOOD DOWEL ④ AND CAM LOCK NUT. ATTACH UPPER SHELF(F) ONTO LEFT FRAME (B) USE WOOD DOWEL ④.

## PASO 2

FIJE LA PLACA DE IMÁN ⑦ EN LA PUERTA (E). CONECTE MANIJA ⑩ EN PUERTA (E) EL USO DE 24 MM TORNILLO ⑨ . COLOQUE LA PUERTA (E) ENTRE EL CENTRO Y EL ESTANTE INFERIOR (D, G). A CONTINUACIÓN, CONECTE (D, G) EN EL MARCO IZQUIERDO (B) USANDO LAS CLAVIJAS DE MADERA ④ Y LA TUERCA DE BLOQUEO DE LEVA . FIJE LA REPISA SUPERIOR (F) EN EL MARCO DE LA IZQUIERDA (B) USANDO LAS CLAVIJAS DE MADERA ④.

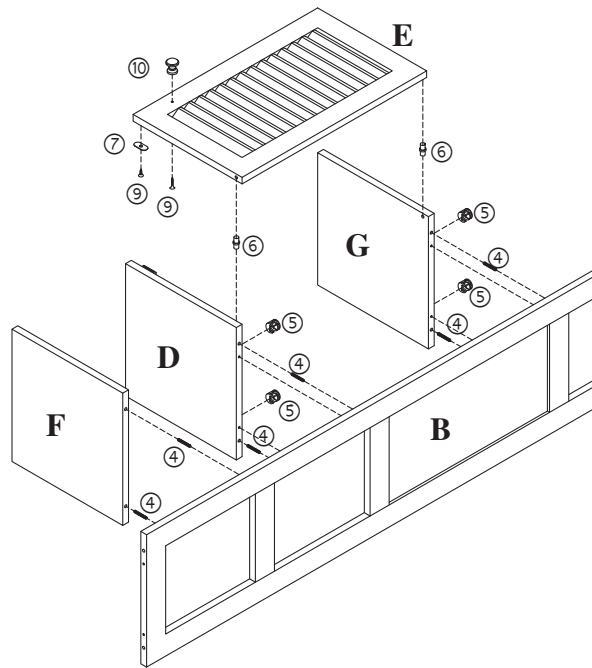

## STEP 3

ATTACH RIGHT FRAME ONTO STEP 2 FINISHED PART USE WOOD DOWEL ④ AND CAM LOCK NUT ⑤ AS SHOWN.

## PASO 3

COLOQUE EL MARCO A LA DERECHA EN EL PASO 2 ACABADO USANDO LAS CLAVIJAS DE MADERA ④ Y ⑤ TUERCA DE LEVA COMO SE MUESTRA.

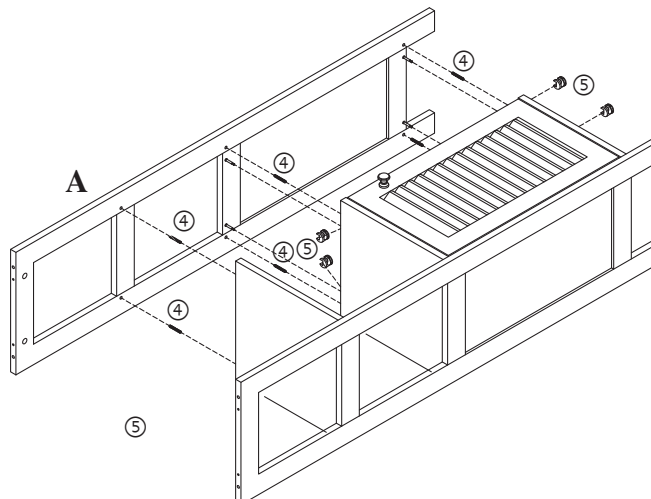

**STEP 4**

**ATTACH BACK BOARD(H) ONTO STEP 3 FINISHED PART USE 11MM SCREW WITH SPACERⓂ.**

**PASO 4**

**VUELVA A COLOCAR LA PLACA (H) EN EL PASO 3 PARTE TERMINADO UTILIZANDO TORNILLO 11MM CON Ⓜ ESPACIADOR.**

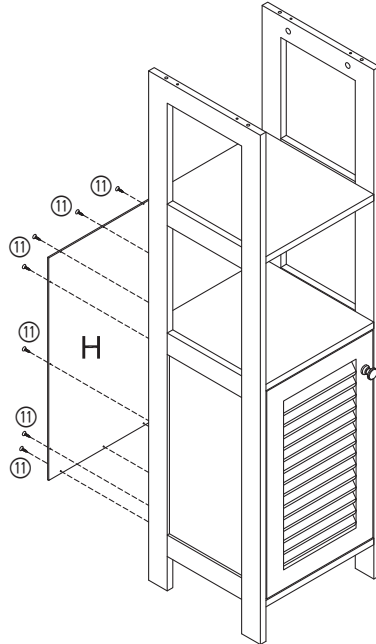

**STEP 5**

**ATTACH TOP PANEL ONTO STEP 4 FINISHED PART USE WOOD DOWEL Ⓞ AND CAM LOCK NUT Ⓟ**

**PASO 5**

**FIJE EL PANEL SUPERIOR EN EL PASO 4 TERMINADO USANDO LAS CLAVIJAS DE MADERA Ⓞ Y LA LEVA DE BLOQUEO TUERCA Ⓟ.**

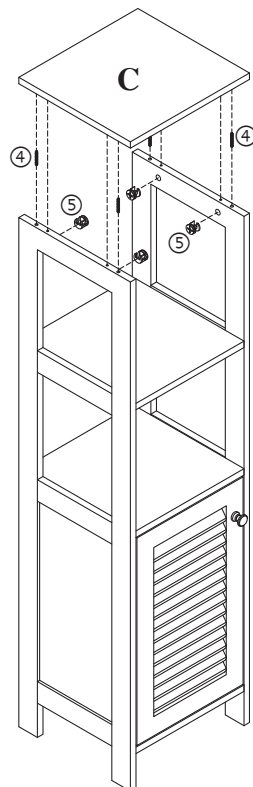

## STEP 6

USE PLASTIC NUT ⑫ AND 32MM LARGE SCREW ⑬ ATTACH DOOR CABINET ONTO WALL BY FIT PART ⑭ AS SHOWN.

## PASO 6

UTILICE LA TUERCA DE PLÁSTICO ⑫ Y TORNILLO GRANDE DE 32MM ⑬ COLOQUE LA PUERTA DEL ARMARIO ⑭ COMO SE MUESTRA.

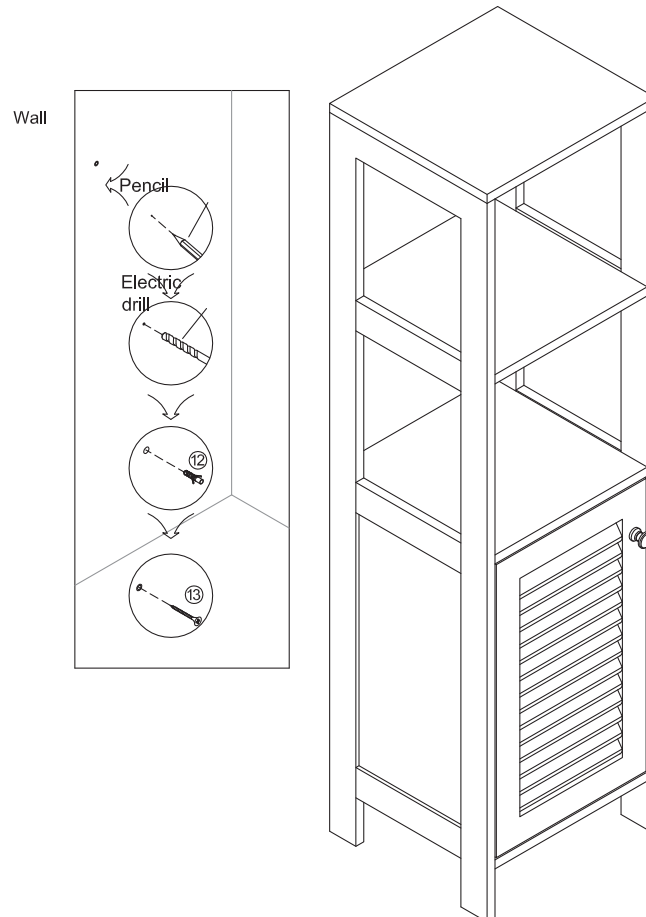

This unit is intended for use with items that don't exceed the maximum weights indicated. Use with products heavier than the maximum weights indicated may result in damage to the desk or instability causing possible injury. Furniture can tip over or break if improperly moved. Have a friend help lift and carry the desk whenever moving to a new location.

Esta unidad está destinada sólo para su uso con los productos y pesos máximos indicados. Si usted utiliza esta mesa con otros productos o de los productos más pesados que el peso máximo indicado, puede causar inestabilidad y puede dar lugar a posibles lesiones. La mesa puede volcarse o romperse si es trasladada indebidamente. Se sugiere tener un amigo para que le ayude a levantar y transportar la mesa a su nueva ubicación.

Do you have any questions? Missing small parts or hardware? If you need assistance with the assembly of your BATHROOM CABINET please e-mail our Customer Service Department at:

**support@fourstari.com** or call us at **(800) 639-3803** or **(508) 473-7688** if calling locally from Massachusetts area

Please include the following information in your email:

- Where item was purchased
- Item, model, style or SKU number listed on instructions or box
- Part number, description of the part and quantity needed

This information will help us get the proper part to you faster

¿Tiene alguna pregunta? ¿Faltan piezas o accesorios pequeños? Si necesita ayuda para ensamblar su MUEBLE DE BAÑO envíenos un correo electrónico a nuestro Departamento de atención al cliente:

**ayuda@fourstari.com** o llámenos al **(800) 639-3803** o **(508) 473-7688** si llama desde la zona de Massachusetts Incluya la siguiente información en el correo electrónico:

- Dónde compró el producto
- El número de artículo, SKU, estilo, modelo o producto que aparece en las instrucciones o la caja
- El número y descripción de la pieza y la cantidad que necesita

Esta información nos ayudará a enviarle la pieza correcta con mayor rapidez