

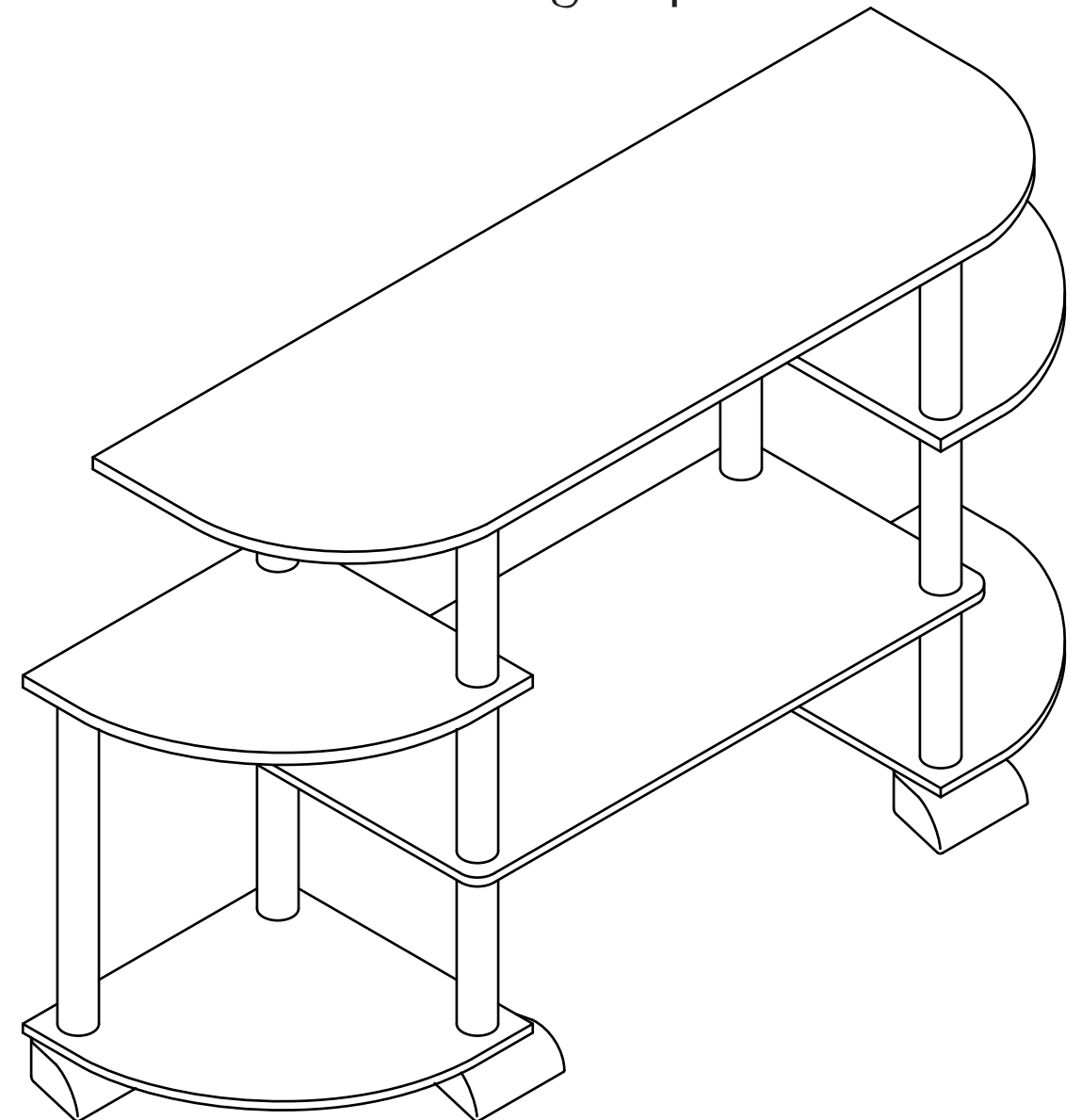









fourstargroup

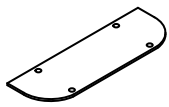
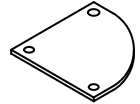

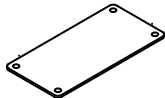
MODEL: 11224609 / MODELO: 11224609

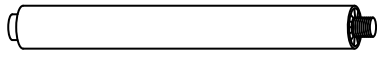
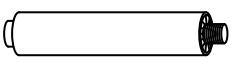
**ENTERTAINMENT CENTER**  
**CENTRO DE**  
**ENTRETENIMENTO**

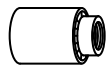
## PARTS AND HARDWARE LISTA DE PARTES Y HARDWARE

NO	HARDWARE LIST LISTA DE HARDWARE	QTY CNT
A	TOP PANEL PANEL SUPERIOR 	1PC 1PZ
B	LEFT TOP PANEL PANEL SUPERIOR IZQUIERDO 	1PC 1PZ
C	RIGHT TOP PANEL PANEL SUPERIOR DERECHO 	1PC 1PZ
D	CENTER PANEL PANEL CENTRAL 	1PC 1PZ
E	BOTTOM SIDE PANEL PANEL LATERAL INFERIOR 	2PCS 2PZS
1	LONG TUBE TUBO LARGO 	2PCS 2PZS
2	SHORT TUBE TUBO CORTO 	12PCS 12PZS
3	INSERT CAP TAPA CON ROSCA INSERTABLE 	6PCS 6PZS
4	LEG PATA 	2PCS 2PZS
5	DUCK LEG PATA ANTI-VOLCANTE 	4PCS 4PZS

### ASSEMBLY TOOLS REQUIRED / HERRAMINETAS NECESARIAS

**RUBBER Mallet / MASO DE GOMA**

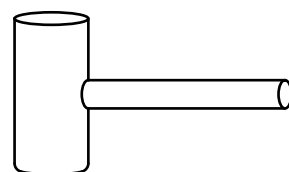

### STEP 5

**ATTACH BOTTOM SIDE PANEL (E) AND TIGHTEN WITH LEG (4) & DUCK LEG (5).  
UPRIGHT THE ENTERTAINMENT CENTER.**

### PASO 5

**ADJUNTE EL PANEL LATERAL INFERIOR (E); AJUSTE LAS PATAS (4) & LAS PATAS ANTI-VOLCANTES (5).  
COLOQUE EL CENTRO DE ENTRETENIMINETO HACIA ARRIBA.**

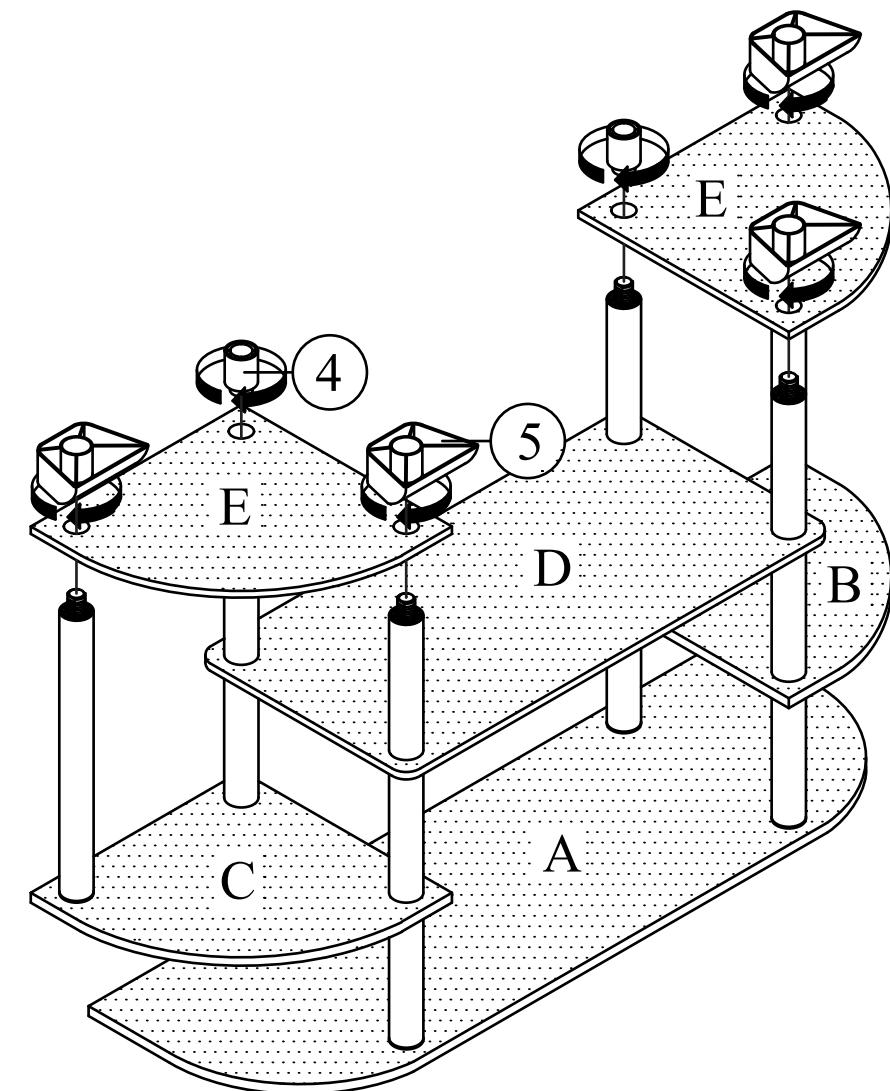

Do you have any questions? Missing small parts or hardware?  
If you need assistance with the assembly of your ENTERTAINMENT CENTER please e-mail our Customer Service Department at: support@fourstari.com or call us at (508) 473-7688 or (800) 639-3803  
Please include the following information in your email:

- Where item was purchased
- Item, model, style or SKU number listed on instructions or box
- Part number, description of the part and quantity needed

This information will help us get the proper part to you faster

¿Tiene alguna pregunta? ¿Faltan piezas o accesorios pequeños?  
Si necesita ayuda para ensamblar su CENTRO DE ENTRETENIMINETO envíenos un correo electrónico a nuestro Departamento de atención al cliente: ayuda@fourstari.com o llámenos al (508) 473-7688 o al (800) 639-3803  
Incluya la siguiente información en el correo electrónico:

- Dónde compró el producto
- El número de artículo, SKU, estilo, modelo o producto que aparece en las instrucciones o la caja
- El número y descripción de la pieza y la cantidad que necesita

Esta información nos ayudará a enviarle la pieza correcta con mayor rapidez

**STEP 4**  
**ATTACH PANEL (D) AND TIGHTEN WITH SHORT TUBE (2).**

**PASO 4**  
**ADJUNTE EL PANEL (D) Y AJUSTELOS CON TUBOS CORTOS (2).**

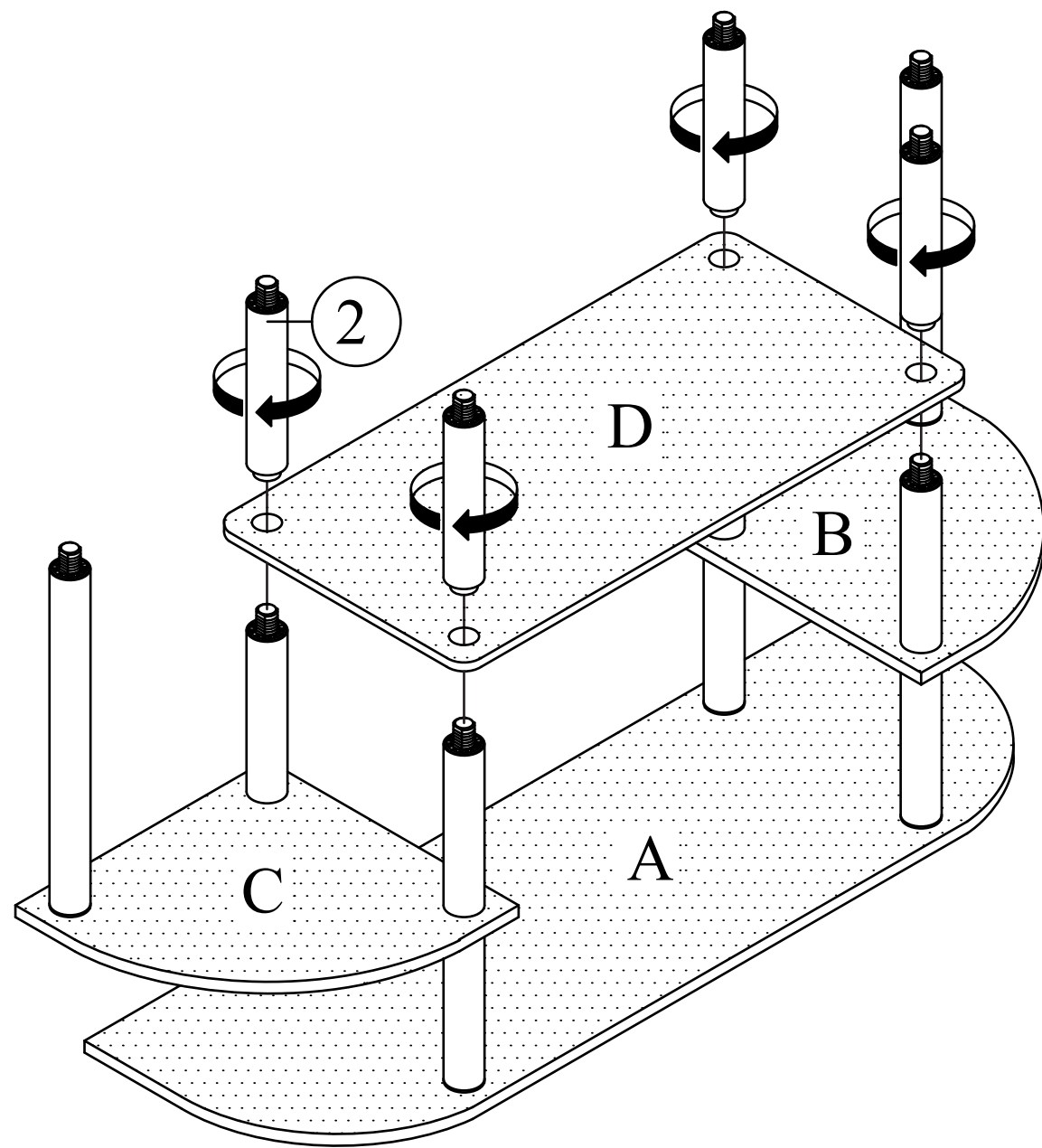

## **ASSEMBLY INSTRUCTIONS** **INSTRUCCIONES DE ASAMBLE**

**CAUTION:**

- 1. READ THIS INSTRUCTION MANUAL BEFORE YOU ASSEMBLE.**
- 2. ASSEMBLE ON SOFT SURFACE TO PREVENT DAMAGE TO FINISH OF PRODUCT.**

**PRECAUCION:**

- 1. LEA ESTE MANUAL DE INSTRUCCIONES ANTES DE ARMAR.**
- 2. ARME ESTE PRODUCTO EN UNA SUPERFICIE BLANDA, PARA PREVENIR DAÑOS AL TERMINADO DE ESTE PRODUCTO.**

**STEP 1**

**INSTALL INSERT CAP (3) INTO PANEL (A) (B) (C) BY USING A RUBBER Mallet.**

**PASO 1**

**INSTALE TAPA CON ROSCA INSERTABLE (3) A LOS PANELES (A) (B) (C) USANDO EL MASO DE GOMA.**

UNFINISHED SURFACE  
SUPERFICIE SIN TERMINAR

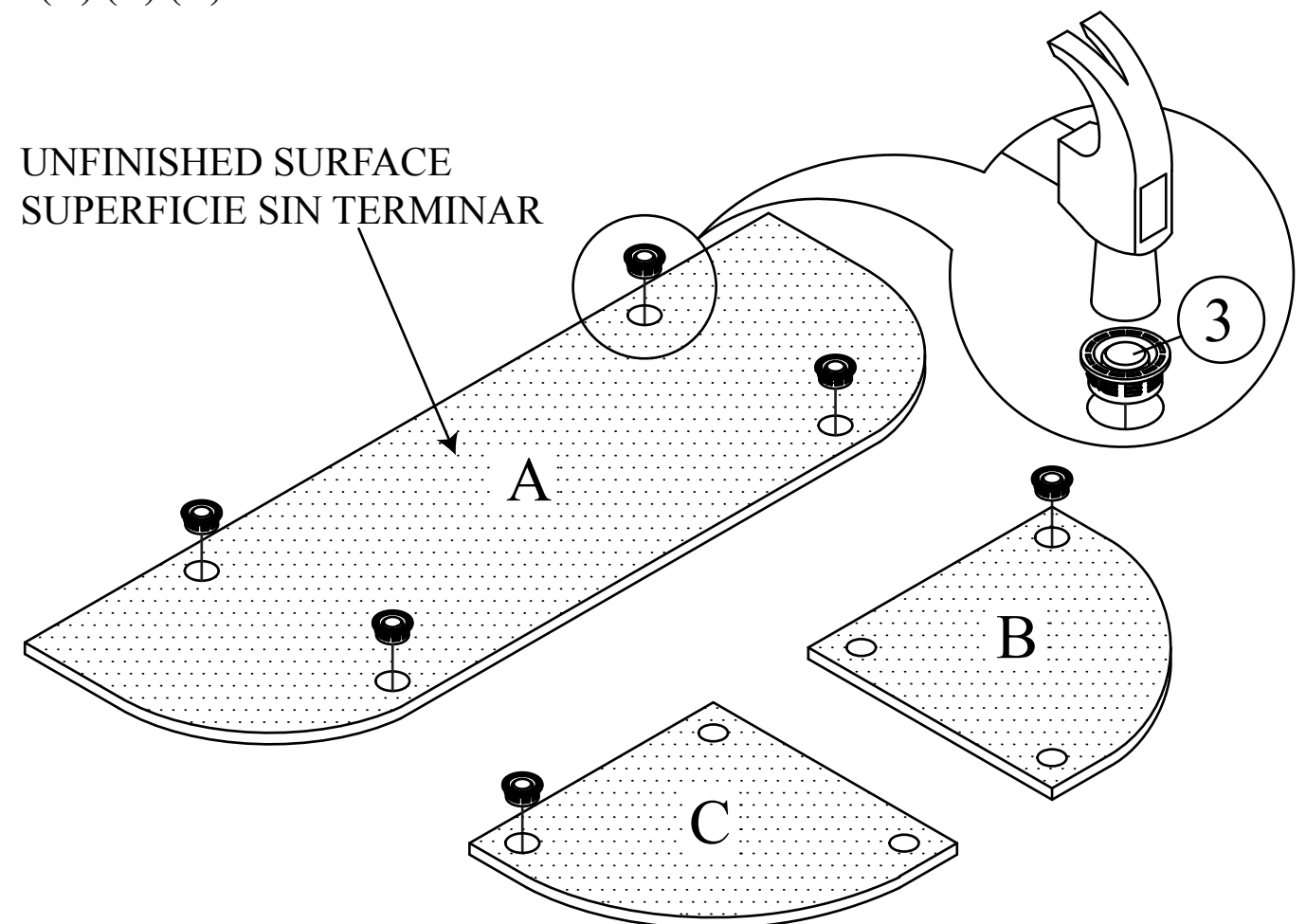

**STEP 2**  
**ATTACH SHORT TUBE (2) TO PANEL (A) AND TIGHTEN.**

**PASO 2**  
**ADJUNTE LOS TUBOS CORTOS (2) AL PANEL (A) Y AJUSTELOS.**

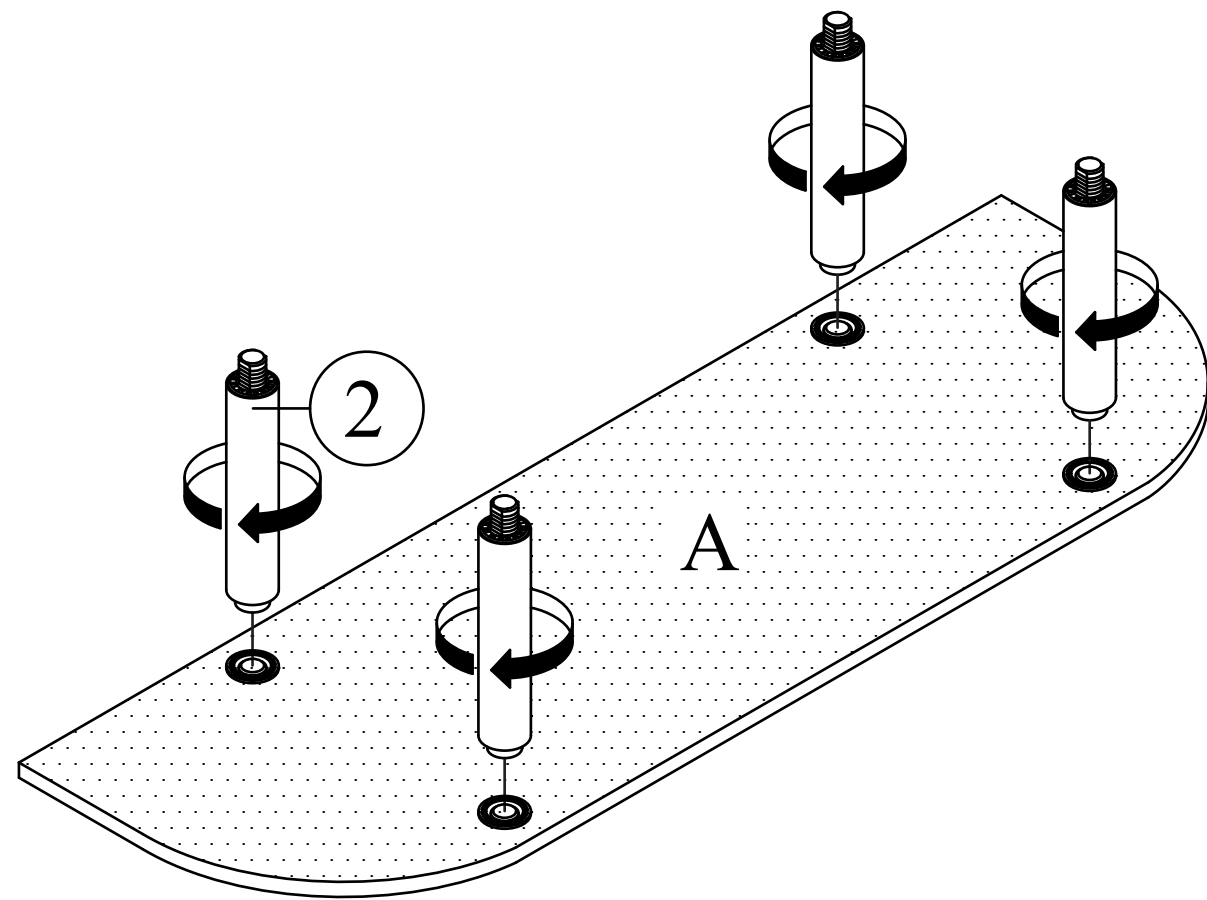

**STEP 3**  
**ATTACH PANEL (B) (C) AND TIGHTEN WITH LONG TUBE (1) AND SHORT TUBE(2).**

**PASO 3**  
**ADJUNTE LOS PANELES (B) (C); LUEGO AJUSTELOS CON UN TUBO LARGO (1) Y TUBO CORTO (2).**

