

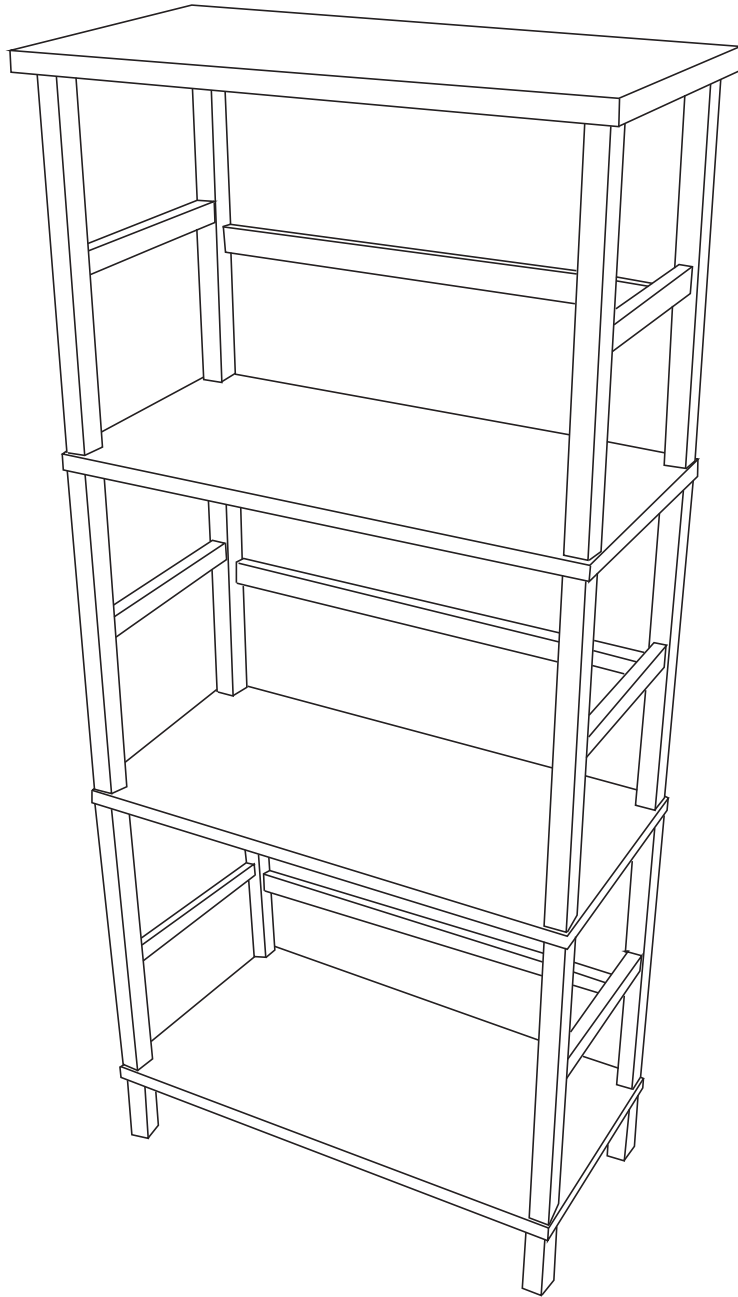











fourstargroup

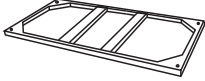

MODEL: 11224207

FOUR TIER BOOKSHELF

PARTS LIST AND HARDWARE

NO	HARDWARE LIST		QTY
A		TOP PANEL	1PC
B		PANEL	3PCS
C		SIDE BAR (WITH SHORT BOLT)	2PCS
D		SIDE BAR (WITH SHORT BOLT)	2PCS
E		SIDE BAR (WITH LONG BOLT)	4PCS
F		SIDE BAR (WITH LONG BOLT)	4PCS
G		CROSS BAR	6PCS
H		FEET	4PCS
I		BACK BAR	3PCS
J		WOOD SCREW	6PCS

ASSEMBLY INSTRUCTIONS

CAUTION:

1. READ THIS INSTRUCTION MANUAL BEFORE YOU ASSEMBLE SET.
2. ASSEMBLE ON SOFT SURFACE TO PREVENT DAMAGE TO FINISH OF PRODUCT.

ASSEMBLY TOOL REQUIRED
PHILIPS SCREWDRIVER.

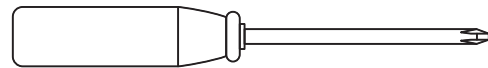

STEP 1

- 1.1 PLACE TOP PANEL (A) FACE DOWN ON SOFT CLOTH IN ORDER TO PROTECT SURFACE. SCREW SIDE BARS (C, D) INTO TOP PANEL (A), THEN INSERT CROSS BARS (G) BETWEEN SIDE BARS (C, D) AS SHOWN.
- 1.2 TAKE SIDE BARS (F, E) THROUGH PANEL (B), SCREW INTO SIDE BARS (D, C) OF 1.1 FINISHED, THEN INSERT CROSS BARS (G) BETWEEN SIDE BARS (F, E) AS SHOWN.
- 1.3 REPEAT THE STEP 1.2 AS SHOWN.
- 1.4 ATTACH PANEL (B) ONTO 1.3 FINISHED USING FEET (H) AS SHOWN.

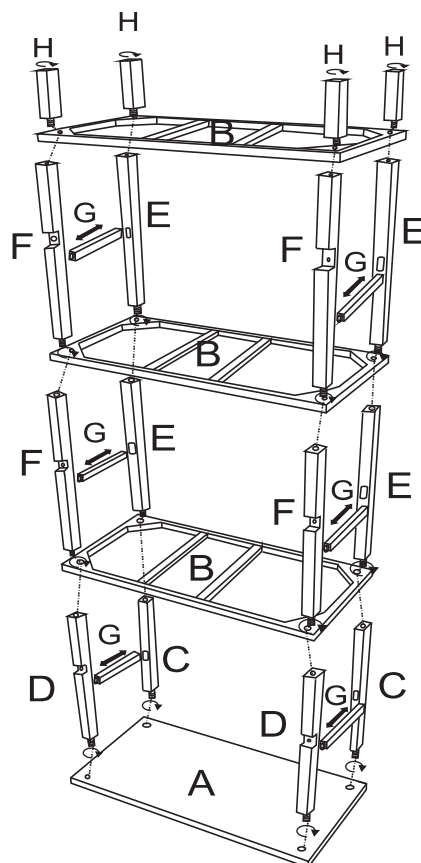

STEP 2

ATTACH BACK BARS (I) INTO STEP 1 FINISHED FRAME USING WOOD SCREW (J) AS SHOWN.

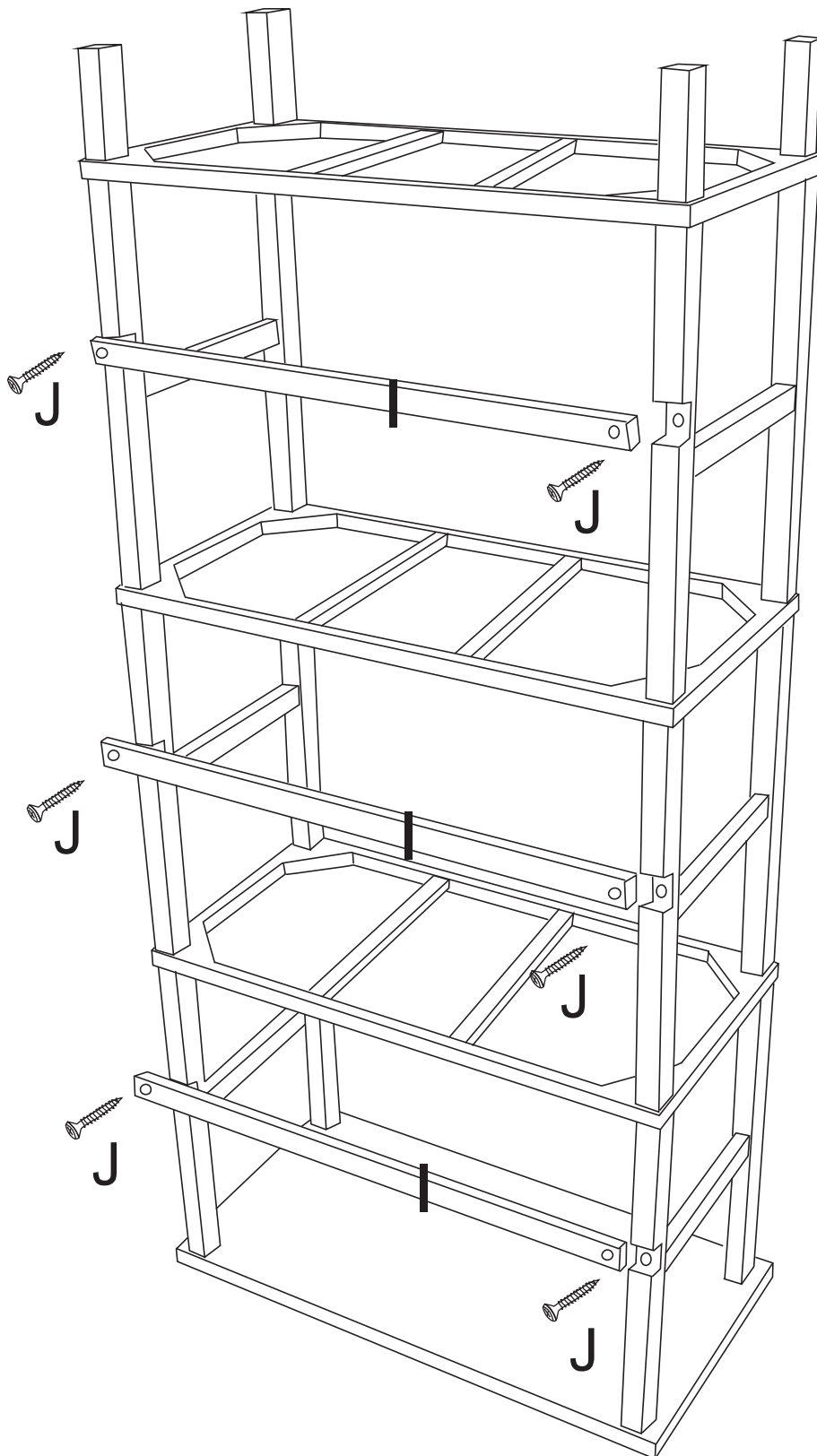

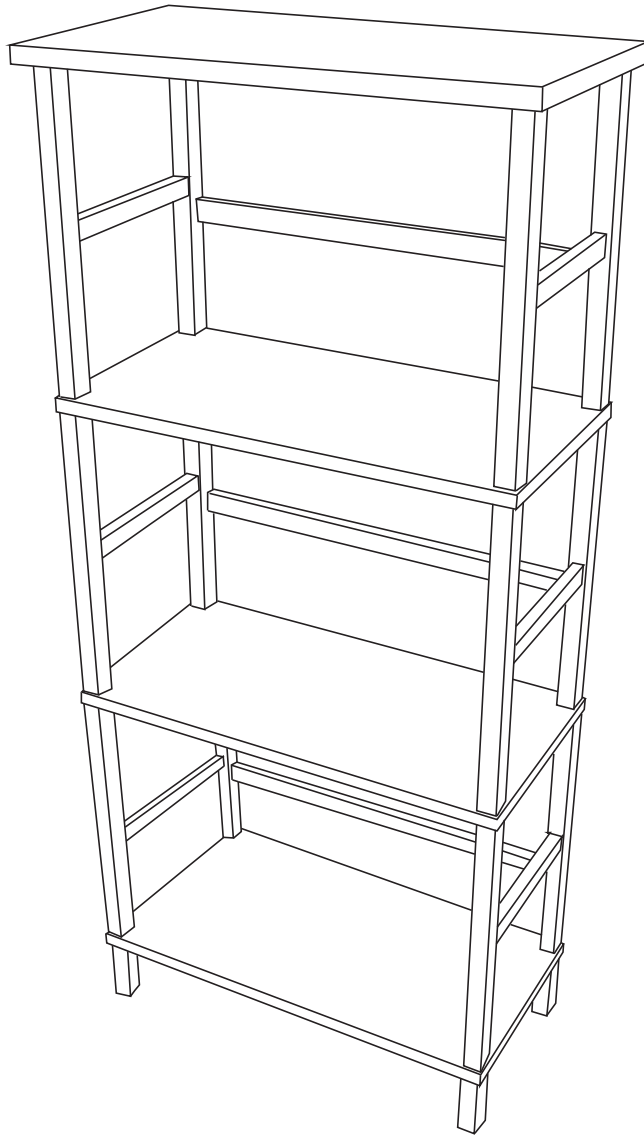







MAXIMUM LOADING CAPACITY OF EACH SHELF IS 15 LBS.

IF NECESSARY, PLEASE FOLLOW BELOW INSTRUCTION TO PREVENT PRODUCT TIP OVER.

PARTS

HARDWARE LIST			QTY
			2 SETS
WALL PLUG	EYELET SCREW	CABLE TIE	
			
1/4" DRILL BIT			

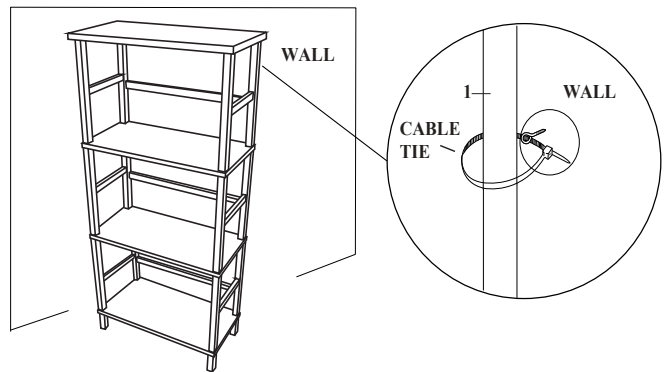

Do you have any questions? Missing small parts or hardware?
 If you need assistance with the assembly of your FOUR TIER BOOKSHELF
 please e-mail our Customer Service Department at:
support@fourstari.com
 or call us at (508) 473-7688 or (800) 639-3803

Please include the following information in your email:

- Where item was purchased
- Item, model, style or SKU number listed on instructions or box
- Part number, description of the part and quantity needed

This information will help us get the proper part to you faster