



MODEL: 11224029
9 BIN WOODEN STORAGE ORGANIZER



- CAUTION :**
1. ADULT SUPERVISION IS REQUIRED DUE TO SMALL PARTS. CARE SHOULD BE TAKEN IN THE UNPACKING AND ASSEMBLING OF THIS PRODUCT.
 2. ASSEMBLE ON SOFT SURFACE TO PREVENT DAMAGE TO THE PRODUCT FINISH.
 3. MAKE SURE ALL PARTS ARE INCLUDED BEFORE ASSEMBLING.

BEFORE YOU BEGIN, PLEASE READ ASSEMBLY INSTRUCTIONS CAREFULLY. FOLLOW STEP BY STEP.

ASSEMBLY TOOLS REQUIRED

PHILIPS SCREWDRIVER



Do you have any questions? Missing small parts or hardware? If you need assistance with the assembly of your 9 BIN WOODEN STORAGE ORGANIZER please e-mail our Customer Service Department at: support@fourstari.com or call us at (800) 639-3803 or (508) 473-7688 if calling locally from Massachusetts area. Please include the following information in your email:
 • Where item was purchased • Item, model, style or SKU number listed on instructions or box • Part number, description of the part and quantity needed
 This information will help us get the proper part to you faster

PARTS LIST AND HARDWARE

NO	HARDWARE & PART LIST	QTY	NO	HARDWARE & PART LIST	QTY
A	TOP SHELF	1 PC	J	SHORT SPINDLE	4 PCS
B	2ND SHELF	1 PC	K	LONG SPINDLE	12 PCS
C	3RD SHELF	1 PC	L	SHORT CROSS BAR	4 PCS
D	4TH SHELF	1 PC	M	LONG CROSS BAR	4 PCS
E	BOTTOM SHELF	1 PC	N	FOOT	4 PCS
F	SHORT BACK PANEL	3 PCS	O	LONG SCREW	8 PCS
G	LONG BACK PANEL	2 PCS	P	SHORT SCREW	14 PCS
H	SMALL BIN	3 PCS	Q	WOODEN DOWEL	12 PCS
I	BIG BIN	6 PCS	R	GLUE	1 PC

ASSEMBLY INSTRUCTIONS

STEP 1
 PLACE THE TOP SHELF (A) SURFACE FACE DOWN ON A SOFT CLOTH/BLANKET IN ORDER TO PROTECT SURFACE, PUT DOWELS (Q) INTO THE SHORT CROSS BAR (L) AND INSERT SHORT CROSS BARS IN THE MIDDLES HOLES, SCREW SHORT SPINDLES (J) AT THE 4 CORNERS. AFTER THAT, PUT 2ND SHELF ON IT AND INSERT LONG CROSS BARS (M) AND SCREW LONG SPINDLES (K) AT THE 4 CORNERS. THEN REPEAT THE SAME STEP FOR THE 3RD SHELF (C). PUT

4TH SHELF (D) ON IT, SCREW LONG SPINDLES (K). FINALLY PLACE BOTTOM SHELF (E) ON THE FRAME AND SCREW THE 4 FEET (N) AS SHOWN.(NOTICE: PLACING SOME GLUE (R) ON THE WOODEN DOWELS (Q) CAN TIGHTEN THE FRAME.)

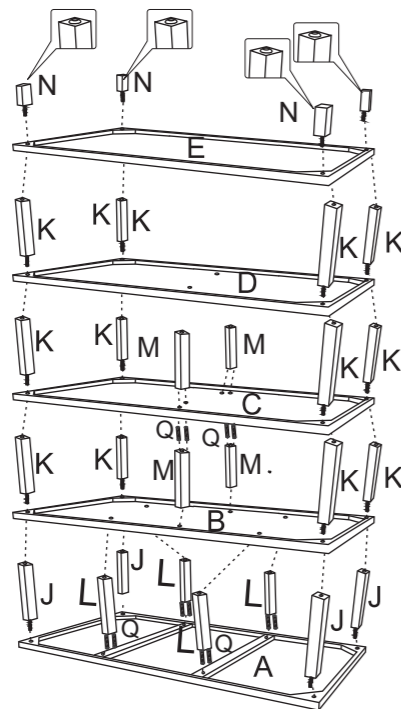

STEP 2
 TURN OVER THE FRAME, USE LONG SCREWS (O) TO SCREW THE CROSS BARS AS SHOWN.

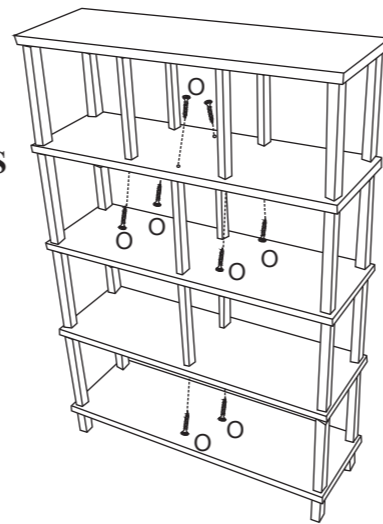

STEP 3
 ATTACH THE SHORT BACK PANELS (F) AND LONG BACK PANELS (G) TO THE BACK FRAME, USE SHORT SCREWS (P) AS SHOWN.

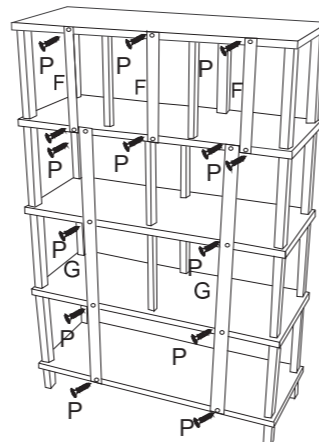

STEP 4
 INSERT THE SMALL BINS (H) ON THE FIRST FLOOR AND BIG BINS ON THE OTHER FLOORS AS SHOWN.

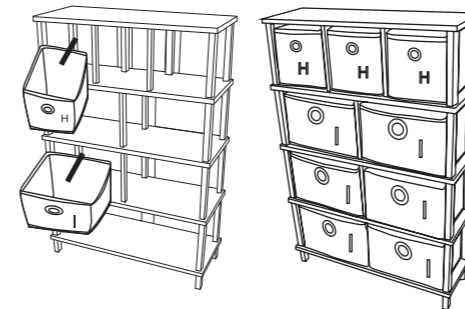

IF NECESSARY, PLEASE FOLLOW BELOW INSTRUCTION TO PREVENT PRODUCT TIP OVER.

PARTS

HARDWARE LIST			QTY
			2 SETS
WALL PLUG	EYELET SCREW	CABLE TIE	

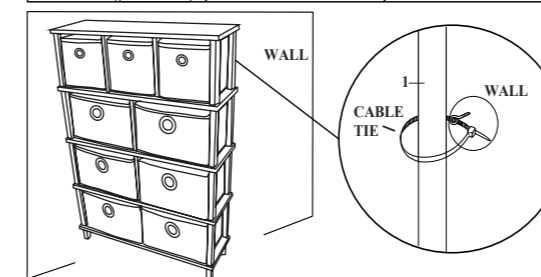
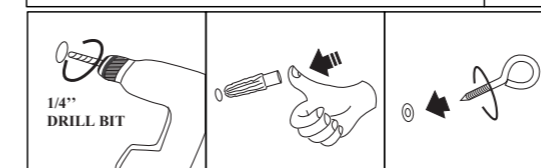

CAUTION: MAXIMUM LOADING CAPACITY IS 40 LBS.
 DO NOT SIT, STAND, LEAN, WALK OR JUMP! FAILURE TO COMPLY WITH THIS CAUTION COULD RESULT IN PERSONAL INJURY AND/OR PROPERTY DAMAGE!

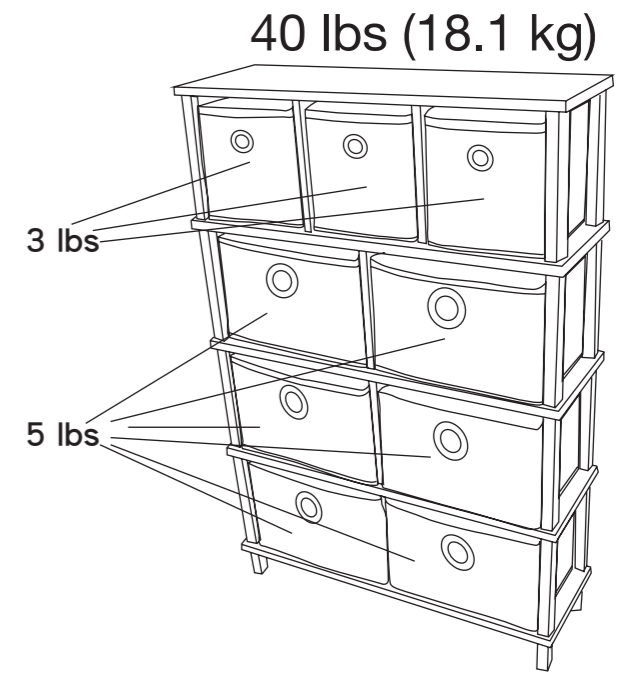

Weight Maximum 40 lbs (18.1 kg)

MODELO: 11224029
ORGANIZADOR DE MADERA DE 9 CAJONES DE TELA



PRECAUCIÓN:

1. SE REQUIERE LA SUPERVISION DE UN ADULTO DEBIDO A LA EXISTENCIA DE PIEZAS PEQUEÑAS. DEBE TENER CUIDADO AL DESEMPACAR Y EN EL MONTAJE DE ESTE PRODUCTO.
2. ENSAMBLELO SOBRE SUPERFICIES SUAVES PARA EVITAR DAÑAR EL ACABADO DEL PRODUCTO.
3. ASEGURESE DE QUE ESTÉN TODAS LAS PIEZAS ANTES DEL MONTAJE.

ANTES DE COMENZAR, POR FAVOR LEA CUIDADOSAMENTE LAS INSTRUCCIONES DE MONTAJE. SEGUIRLAS PASO A PASO.









HERRAMIENTAS NECESARIAS

DESTORNILLADOR PHILLIPS

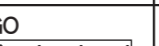

¿Tiene alguna pregunta? ¿Faltan piezas o accesorios pequeños? Si necesita ayuda para ensamblar su ORGANIZADOR DE MADERA DE 9 CAJONES DE TELA envíenos un correo electrónico a nuestro Departamento de atención al cliente: ayuda@fourstari.com o llámenos al (800) 639-3803 o (508) 473-7688 si llama desde la zona de Massachusetts Incluya la siguiente información en el correo electrónico:
 • Dónde compró el producto • El número de artículo, SKU, estilo, modelo o producto que aparece en las instrucciones o la caja • El número y descripción de la pieza y la cantidad que necesita
 Esta información nos ayudará a enviarle la pieza correcta con mayor rapidez

LISTA DE PARTES Y ACCESORIOS

NO	LISTA DE PARTES Y ACCESORIOS	CNT	NO	LISTA DE PARTES Y ACCESORIOS	CNT
A	ESTANTE SUPERIOR 	1 PZ	J	EJE CORTO 	4 PZS
B	SEGUNDO ESTANTE 	1 PZ	K	EJE LARGO 	12 PZS
C	TERCER ESTANTE 	1 PZ	L	TRAVESAÑO CORTO 	4 PZS
D	CUARTO ESTANTE 	1 PZ	M	TRAVESAÑO LARGO 	4 PZS
E	ESTANTE INFERIOR 	1 PZ	N	PATA 	4 PZS
F	PANEL TRASERO CORTO 	3 PZS	O	TORNILLO LARGO 	8 PZS
G	PANEL TRASERO LARGO 	2 PZS	P	TORNILLO CORTO 	14 PZS
H	CAJON PEQUEÑO 	3 PZS	Q	CLAVIJA DE MADERA 	12 PZS
I	CAJON GRANDE 	6 PZS	R	PEGAMENTO 	1 PZ

INSTRUCCIONES DE ENSAMBLAJE

PASO 1
 COLOQUE EL ESTANTE SUPERIOR (A) CON LA SUPERFICIE TERMINADA BOCA ABAJO EN UNA SUAVE TELA / MANTA CON EL FIN DE PROTEGER EL TERMINADO, COLOCAR LAS CLAVIJAS (Q) EN LA BARRA TRANSVERSAL CORTO (L) E INSERTAR BARRAS CRUZADAS CORTO EN LOS AGUJEROS DEL CENTRO, LUEGO ATORNILLE LOS EJES CORTOS (J) EN LAS 4 ESQUINAS. DESPUÉS DE ESTO, PONGA EL SEGUNDO ESTANTE EN ÉL E INSERTAR LAS BARRAS CRUZADAS LARGO (M) Y

ATORNILLE EJES LARGOS (K) EN LAS 4 ESQUINAS. A CONTINUACIÓN, REPITA EL MISMO PASO PARA EL TERCER ESTANTE (C). COLOQUE EL CUARTO ESTANTE (D) EN ÉL, ATORNILLE EJES LARGOS (K). FINALMENTE COLOQUE EL ESTANTE INFERIOR (E) EN EL MARCO Y ATORNILLE LAS 4 PATAS (N) COMO SE MUESTRA.

(ADVERTENCIA: COLOCAR PEGAMENTO (R) EN LAS CLAVIJAS DE MADERA (Q) PUEDE AFIRMAR EL MARCO.)

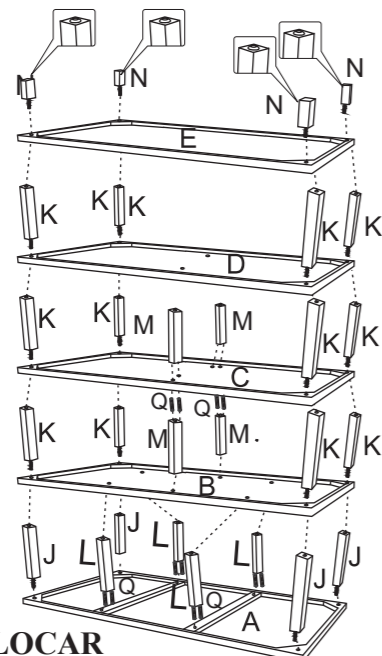

PASO 2
 DÉ LA VUELTA LA ESTRUCTURA, UTILICE LOS TORNILLOS LARGOS (O) PARA ATORNILLAR LAS BARRAS TRANSVERSALES, COMO SE MUESTRA.

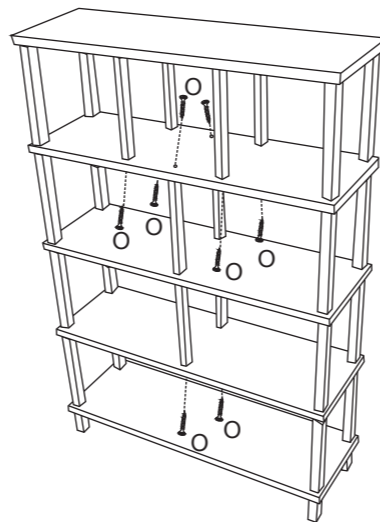

PASO 3
 FIJE LOS PANELES TRASEROS CORTOS (F) Y LOS PANELES TRASEROS LARGOS (G) A LA PARTE TRASERA DE LA ESTRUCTURA, UTILIZANDO TORNILLOS CORTOS (P) COMO SE MUESTRA.

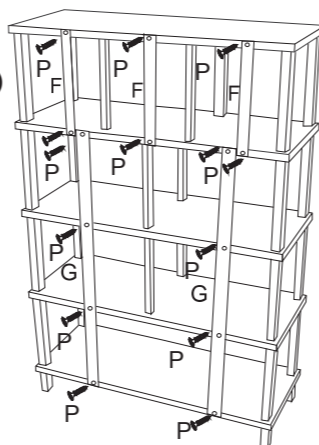

PASO 4
 INSERTE LOS CAJONES PEQUEÑOS (H) EN EL PRIMER ESTANTE Y LOS GRANDES EN LOS ESTANTES SUPERIORES COMO SE MUESTRA.

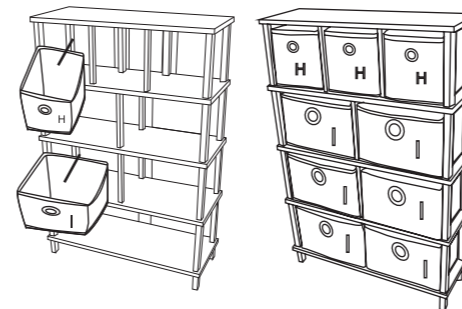

SI ES NECESARIO, POR FAVOR SIGA LAS INSTRUCCIONES PARA EVITAR QUE EL PRODUCTO SE CAIGA O VUELQUE.

PIEZAS

LISTA DE ACCESORIOS			CNT
			2 JUEGOS
ENCHUFE DE PARED			
TORNILLO DE OJAL			
CABLE EMPATE			
			
1/4" BROCA			

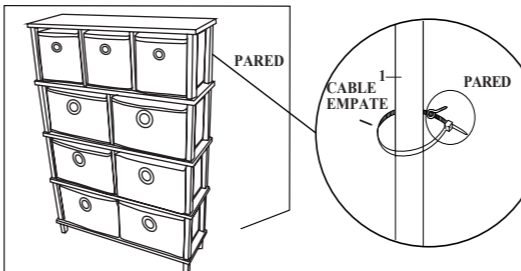

PRECAUCIÓN: LA CARGA MÁXIMA ES DE 40 LBS.
 NO SENTARSE, PARARSE, APOYARSE, CAMINAR O SALTAR!
 EL INCUMPLIMIENTO PUEDE RESULTAR EN LESIONES PERSONALES Y / O DAÑOS A LA PROPIEDAD!

40 lbs (18,1 kg)

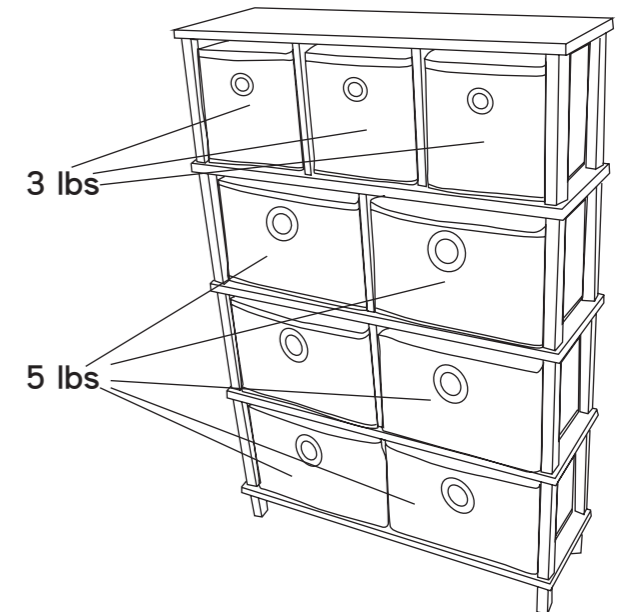

Peso Maximo 40 lbs (18,1 kg)