

ASSEMBLY INSTRUCTION

PAGE :1/3

ITEM NO : 11222980W - 5 TIER TOWER / SET OF 2 END TABLE

BEFORE YOU BEGIN , PLEASE FOLLOW ASSEMBLY INSTRUCTION CAREFULLY , FOLLOW STEP BY STEP .

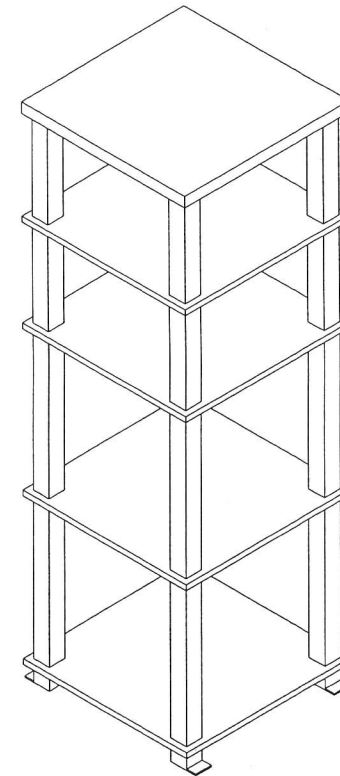
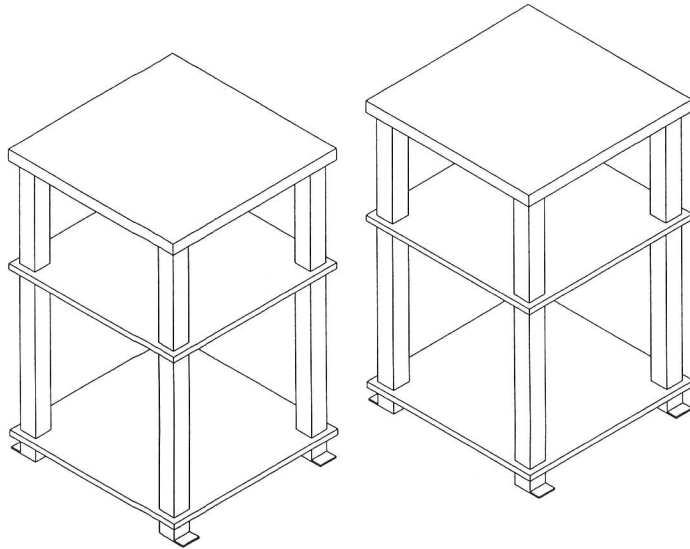

Read instruction carefully . See Furniture Parts list and Hardware List for guidance . Be sure you have all parts before you start assembling .
Place and assemble furniture on a clean flat soft surface , such as carpet or rug to prevent being scratched .

SET OF 2 END TABLE

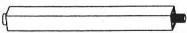
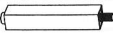

5 TIER TOWER

NO	PARTS LIST	QTY
A	TOP PANEL	2 PCS
B	SHELF PANEL	4 PCS

NO	HARDWARE LIST	QTY
1	LONG SQUARE TUBE 	8 PCS
2	SHORT SQUARE TUBE 	8 PCS
3	INSERT CAP 	8 PCS
4	SQUARE NO-TIP FOOT 	8 PCS

STEP 1 (SET OF 2 END TABLE)

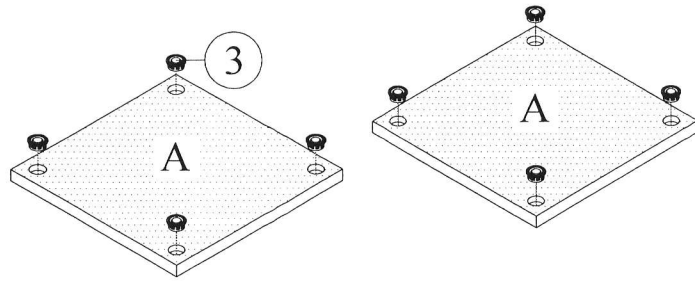

STEP 2 (SET OF 2 END TABLE)

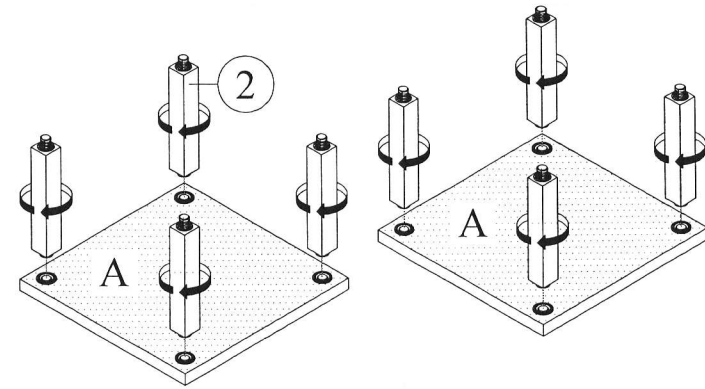

STEP 3 (SET OF 2 END TABLE)

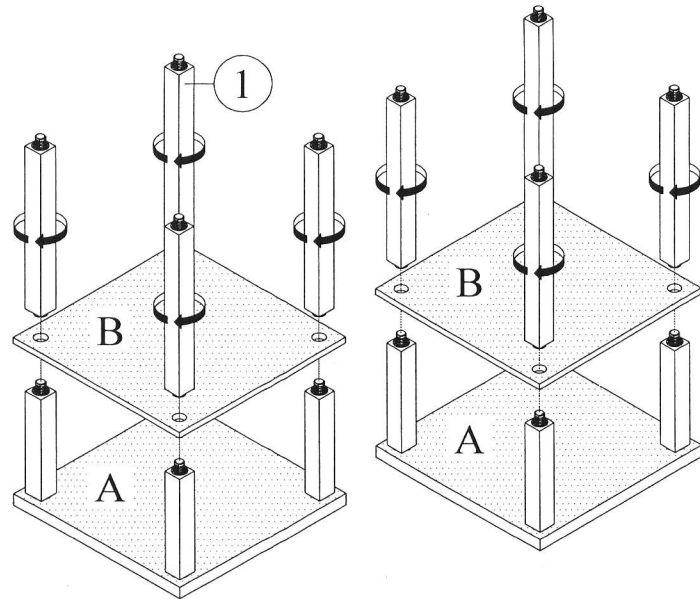

STEP 4 (SET OF 2 END TABLE)

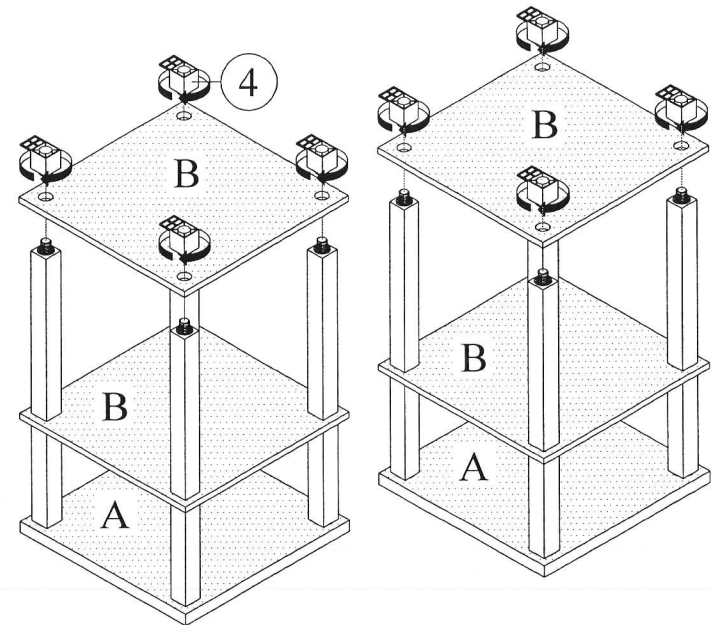

ASSEMBLY INSTRUCTION

PAGE :3/3

ITEM NO : 11222980W - 5 TIER TOWER / SET OF 2 END TABLE

STEP 1 (5 TIER TOWER)

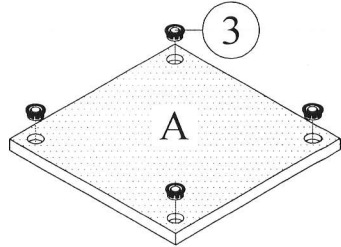

STEP 2 (5 TIER TOWER)

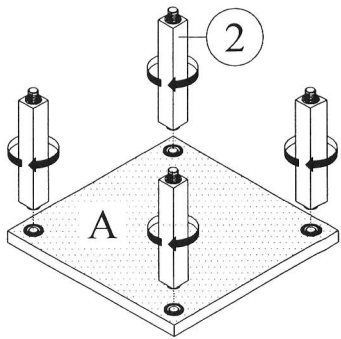

STEP 3 (5 TIER TOWER)

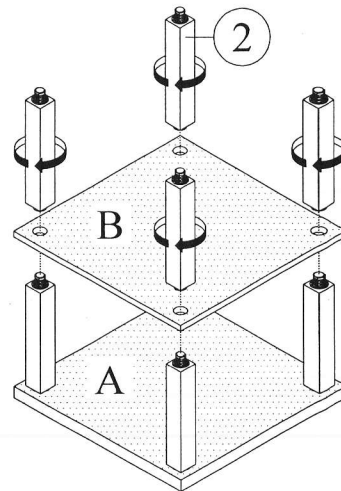

STEP 4 (5 TIER TOWER)

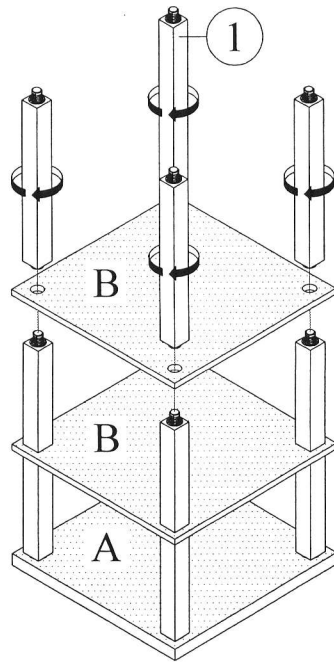

STEP 5 (5 TIER TOWER)

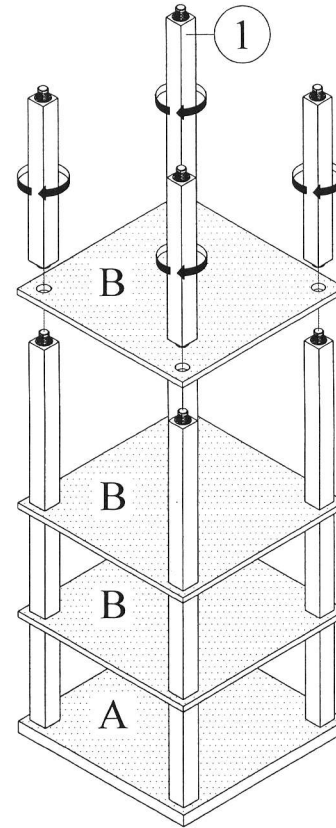

STEP 6 (5 TIER TOWER)

