

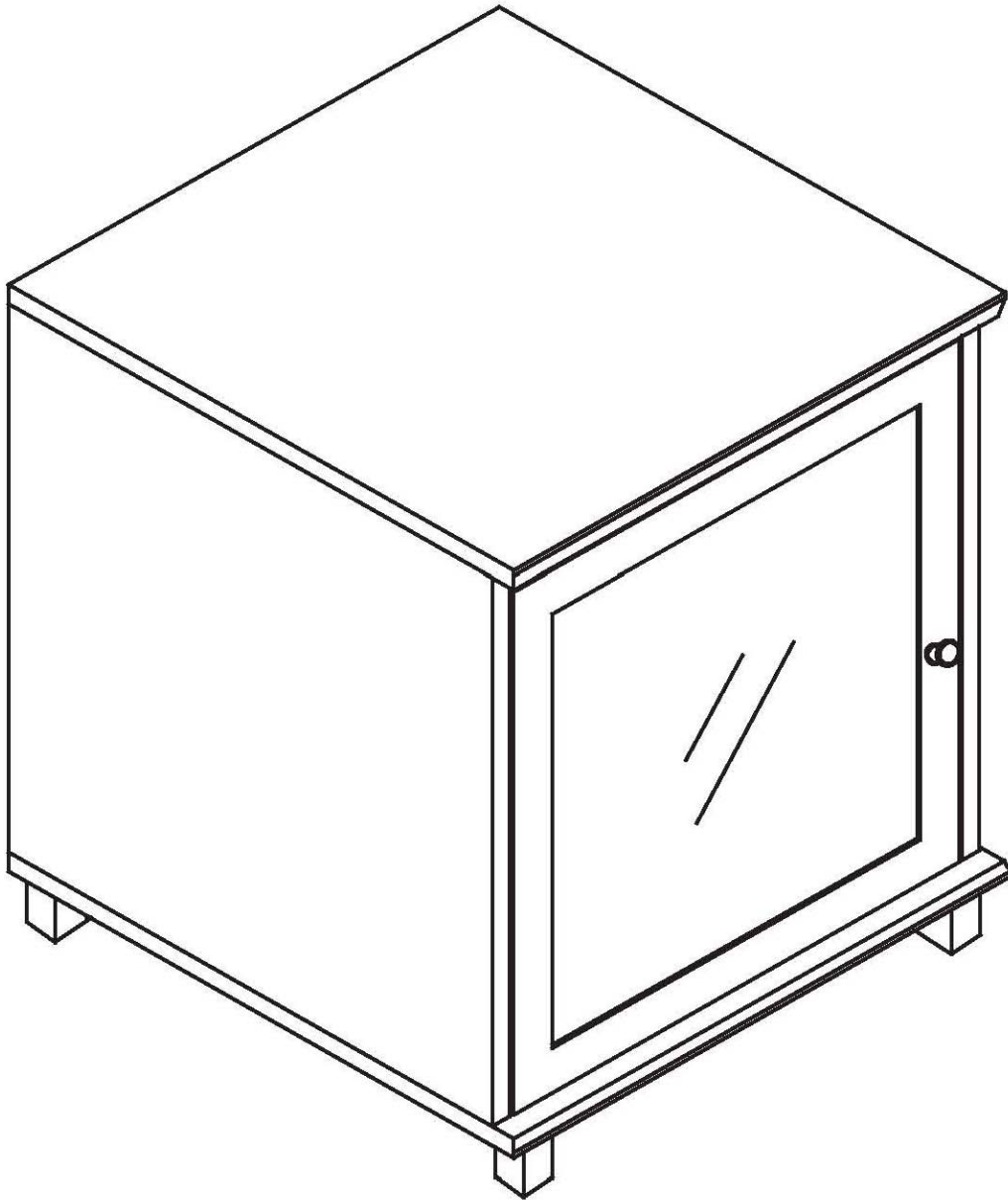





















fourstargroup



**MODEL: 11221736**

**STORAGE CUBE WITH  
GLASS DOOR**

## PARTS AND HARDWARE

NO	HARDWARE LIST	QTY
A	BOTTOM PANEL 	1 PC
B	LEFT SIDE PANEL 	1 PC
C	RIGHT SIDE PANEL 	1 PC
D	MIDDLE PANEL 	1 PC
E	REAR PANEL 	1 PC
F	GLASS DOOR 	1 PC
G	TOP PANEL 	1 PC
H	LEG NUT 	4 PCS
I	LONG SCREW 	4 PCS
J <sub>1</sub>	SHORT WOOD DOWEL 	12 PCS
J <sub>2</sub>	LONG WOOD DOWEL 	4 PCS
K	SHORT SCREW 	8 PCS
L	KNOB 	1 PC
M	BOLT 	1 PC
N	METAL PLATE 	1 PC
O	METAL PLATE SCREW 	2 PCS
P	DOOR NUT 	2 PCS
Q	MAGNET 	1 PC
R	MAGNET SCREW 	2 PCS

**BEFORE YOU BEGIN, PLEASE READ ASSEMBLY INSTRUCTIONS CAREFULLY. FOLLOW THEM STEP BY STEP.**

**CAUTION :**

- 1. ADULT SUPERVISION IS REQUIRED DUE TO SMALL PARTS. CARE SHOULD BE TAKEN IN THE UNPACKING AND ASSEMBLY OF THE PRODUCT.**
- 2. ASSEMBLE ON SOFT SURFACES TO PREVENT DAMAGE TO THE PRODUCT FINISH.**
- 3. MAKE SURE ALL PARTS ARE INCLUDED BEFORE ASSEMBLY.**

**ASSEMBLY TOOLS REQUIRED :**

**PHILLIPS  
SCREWDRIVER**

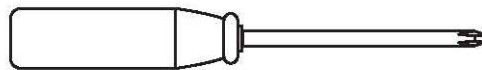

# ASSEMBLY INSTRUCTIONS

## STEP 1

ATTACH LEG NUT (H) TO THE BACK OF BOTTOM PANEL (A) USING LONG SCREW (I) AND LONG WOOD DOWEL (J<sub>2</sub>) AS SHOWN.

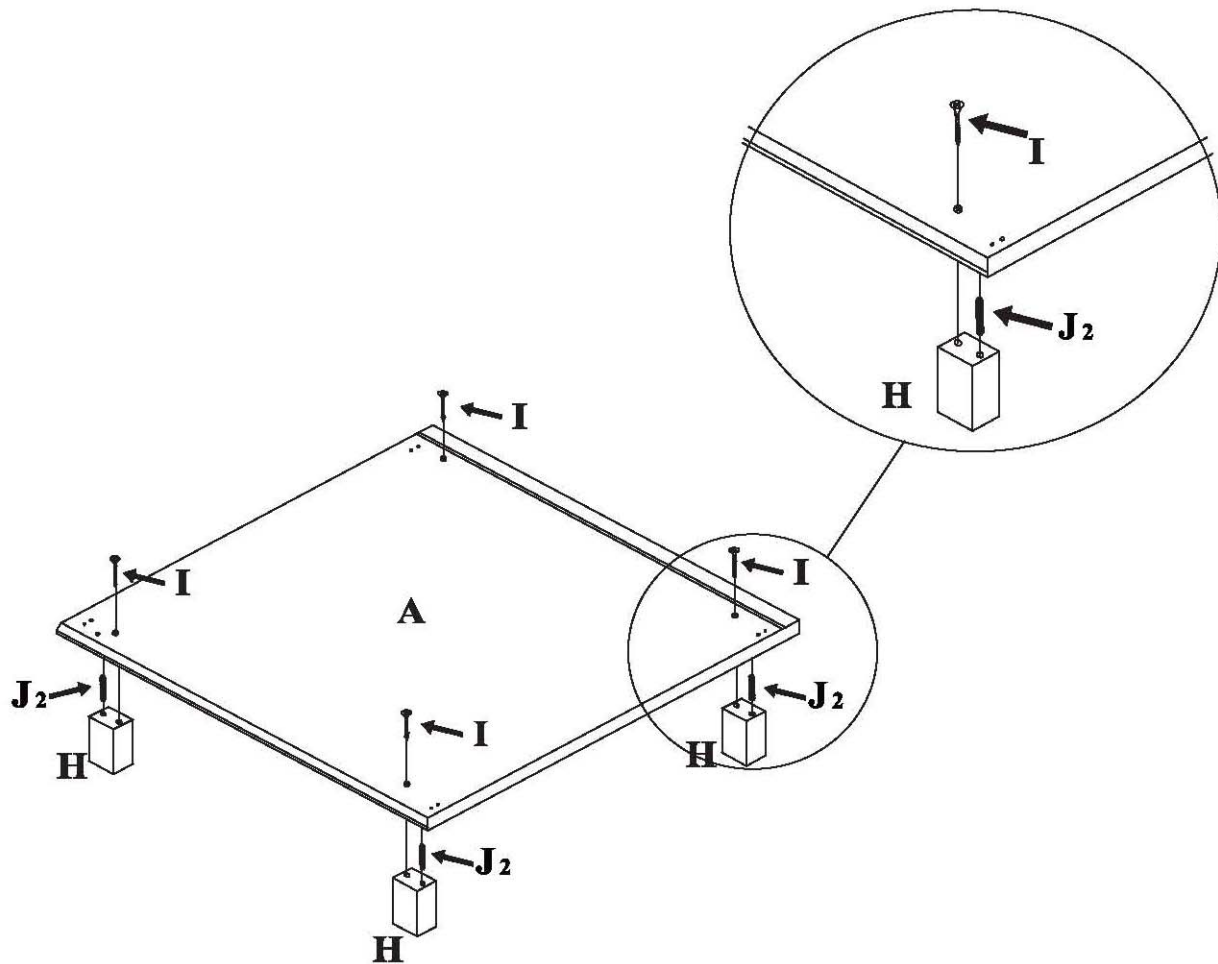

**STEP 2**

**ATTACH MIDDLE PANEL (D) TO LEFT SIDE PANEL (B) AND RIGHT SIDE PANEL (C) USING SHORT WOOD DOWEL (J<sub>1</sub>) AS SHOWN.**

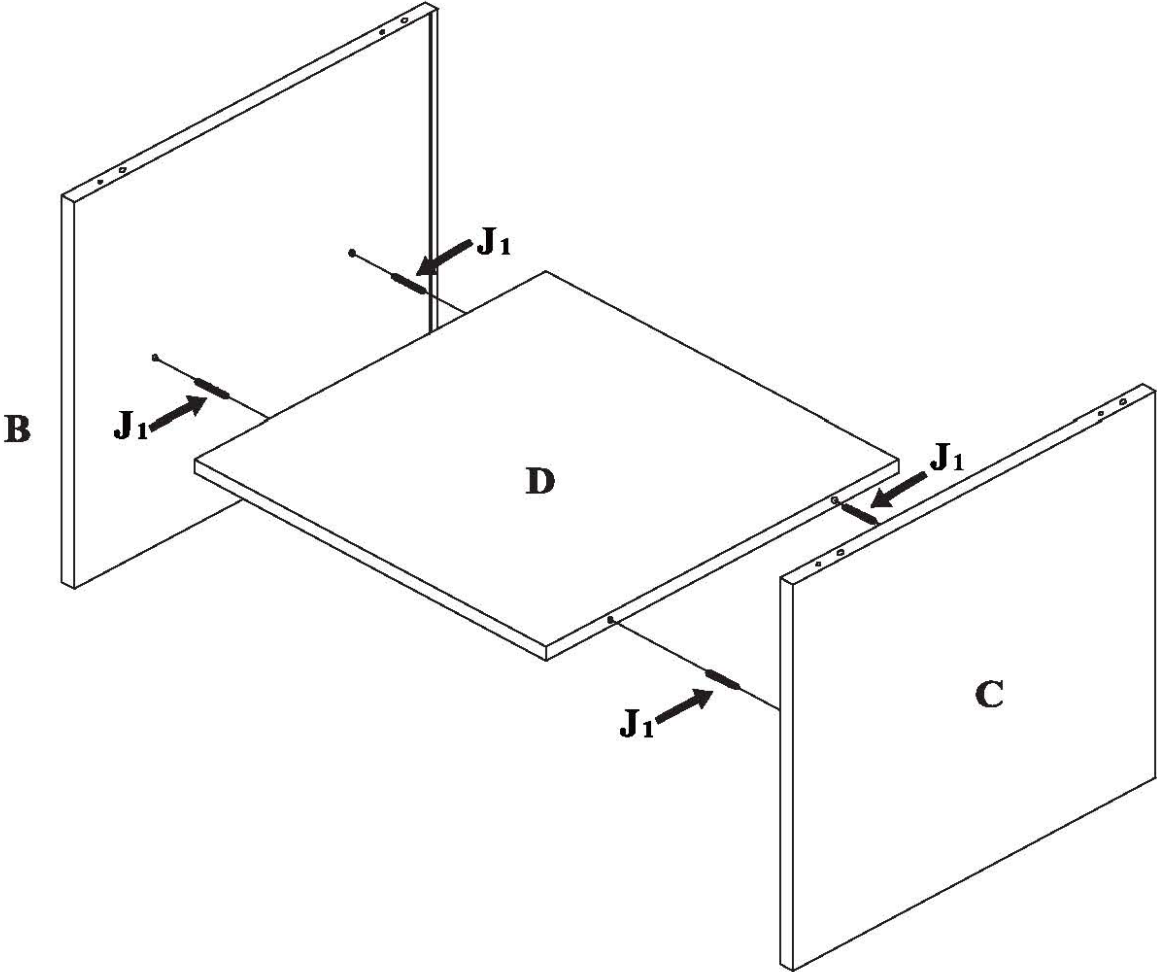

**STEP 3**

**ATTACH LEFT SIDE PANEL (B) AND RIGHT SIDE PANEL (C) TO  
BOTTOM PANEL (A) USING SHORT WOOD DOWEL (J<sub>1</sub>) AND SHORT  
SCREW (K) AS SHOWN.**

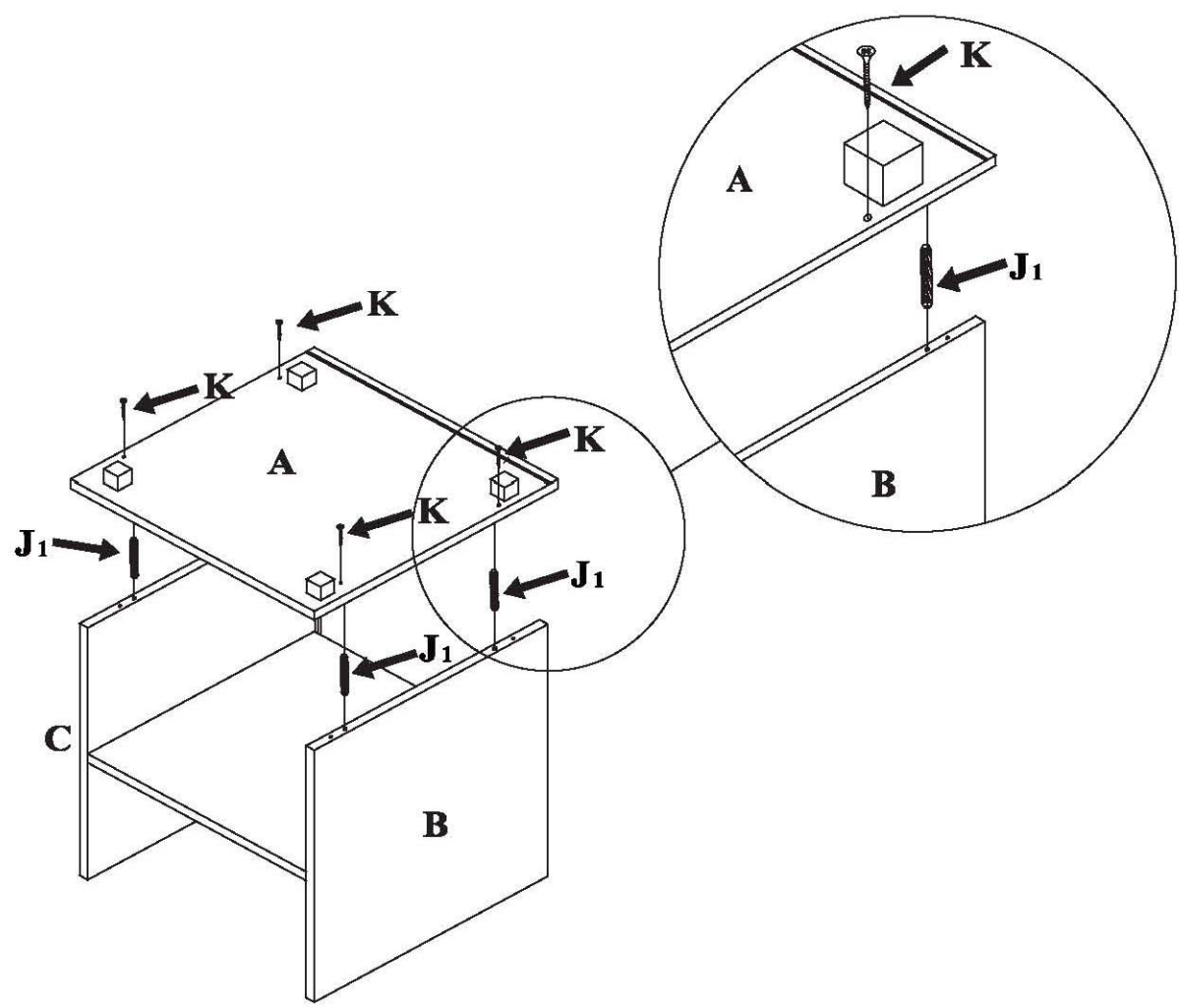

**STEP 4**

**INSERT REAR PANEL (E) TO LEFT SIDE PANEL (B), RIGHT SIDE PANEL (C) AND BOTTOM PANEL (A) THROUGH THE GROOVES AS SHOWN.**

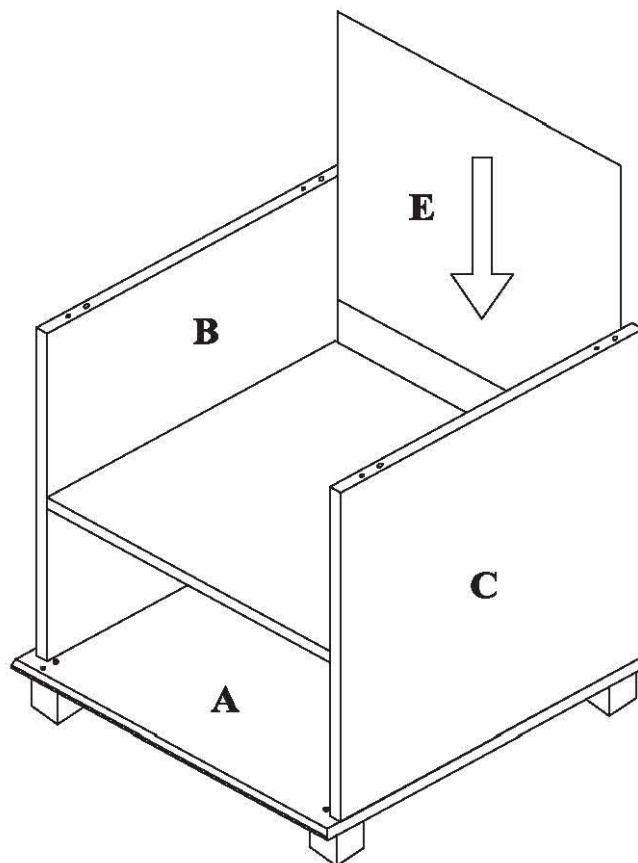

**STEP 5**

**ATTACH KNOB (L) AND METAL PLATE (N) TO GLASS DOOR (F) USING BOLT (M) AND METAL PLATE SCREW (O), THEN ATTACH GLASS DOOR (F) TO BOTTOM PANEL (A) USING DOOR NUT (P) AS SHOWN.**

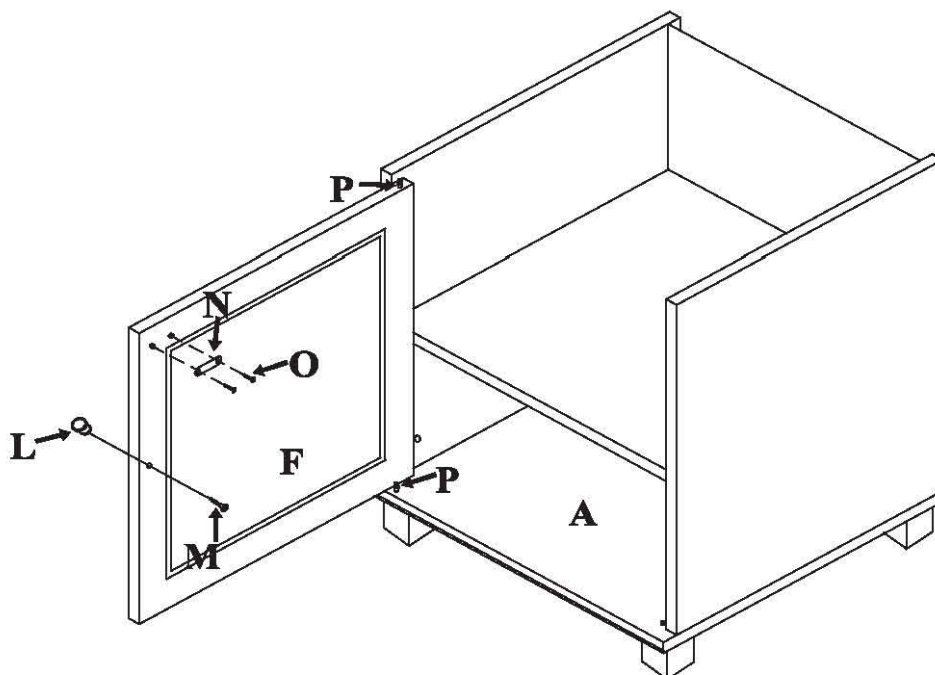

## STEP 6

**6.1 ATTACH MAGNET (Q) TO TOP PANEL (G) USING MAGNET SCREW (R) AS SHOWN.**

**6.2 ATTACH TOP PANEL (G) TO LEFT SIDE PANEL (B) AND RIGHT SIDE PANEL (C) USING SHORT WOOD DOWEL (J<sub>1</sub>), SHORT SCREW (K) AS SHOWN.**

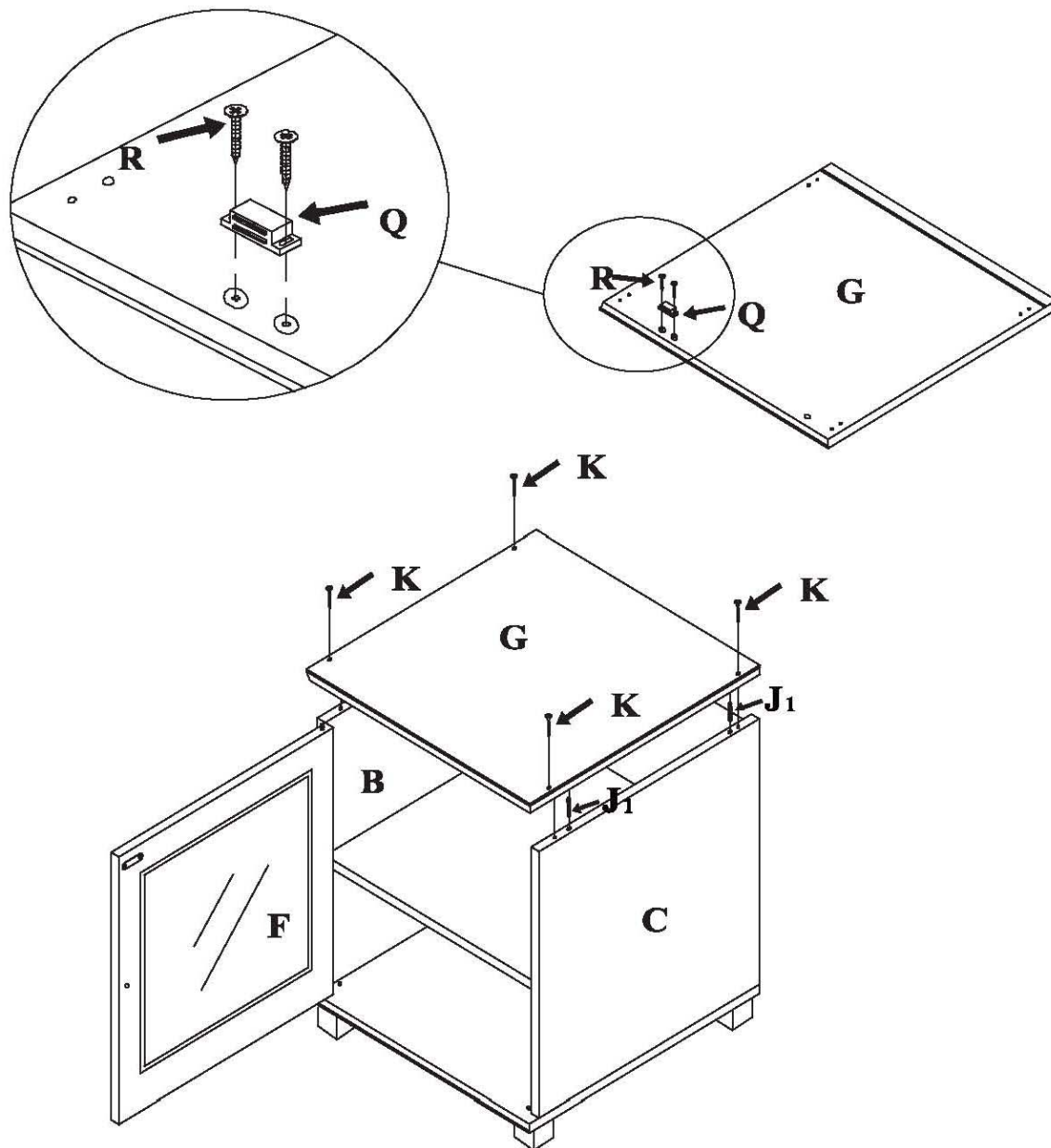

Do you have any questions? Missing small parts or hardware?  
If you need assistance with the assembly of your STORAGE  
CUBE WITH GLASS DOOR please e-mail our Customer Service  
Department at:  
**support@fourstari.com**  
or call us at (508) 435-4830  
or (800) 639-3803

Please include the following information in your email:

- Where item was purchased
- Item, model, style or SKU number listed on instructions or box
- Part number, description of the part and quantity needed

This information will help us get the proper part to you faster