

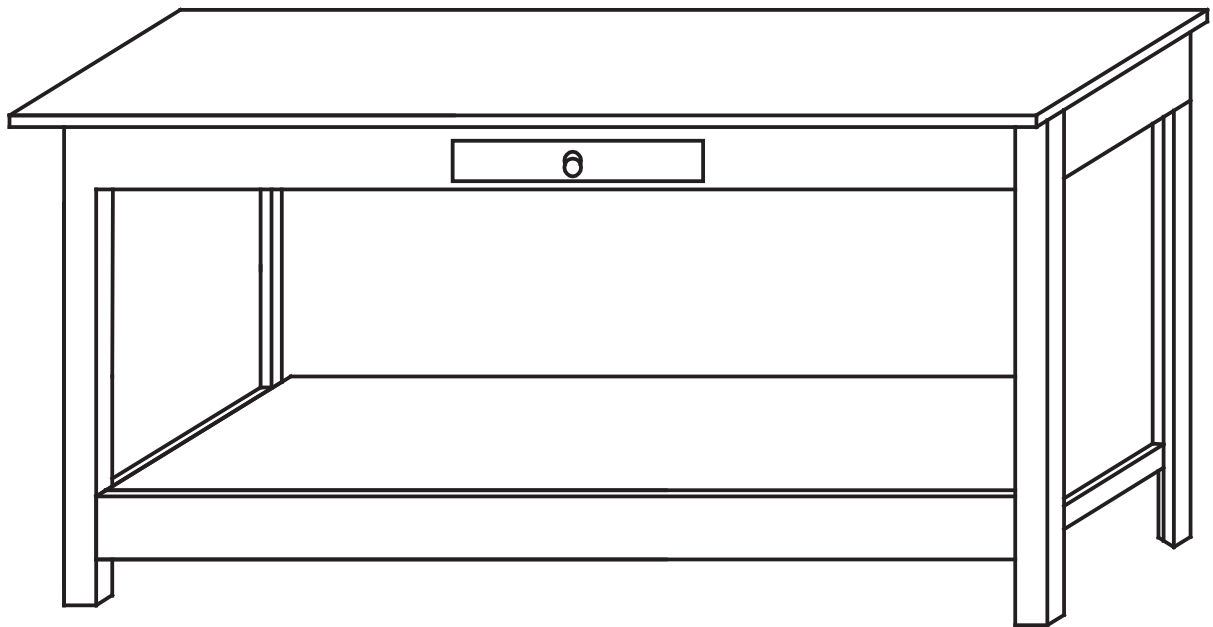











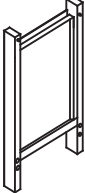
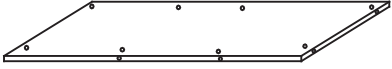
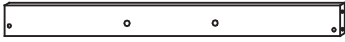
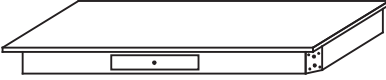

fourstargroup



MODEL: 11221725

**CONSOLE TABLE WITH DRAWER**

# PARTS LIST AND HARDWARE

NO	HARDWARE LIST	QTY
A	<b>LEG PANEL</b> 	2 PCS
B	<b>BOTTOM PANEL</b> 	1 PC
C	<b>SIDE PANEL</b> 	2 PCS
D	<b>TOP PANEL WITH DRAWER</b> 	1 PC
E	<b>CAMLOCK PIN</b> 	12 PCS
F	<b>CAMLOCK</b> 	12 PCS
G	<b>WOOD DOWEL</b> 	4 PCS
H	<b>BOLT</b> 	8 PCS
I	<b>SCREW</b> 	1 PC
J	<b>KNOB</b> 	1 PC
K	<b>WASHER</b> 	8 PCS
L	<b>ALLEN WRENCH</b> 	1 PC
M	<b>METAL PLATE</b> 	2 PCS
N	<b>SHORT SCREW</b> 	2 PCS
O	<b>PLASTIC NUT</b> 	2 PCS
P	<b>LONG SCREW</b> 	2 PCS

# ASSEMBLY INSTRUCTIONS

**BEFORE YOU BEGIN,  
PLEASE READ ASSEMBLY INSTRUCTIONS CAREFULLY.  
FOLLOW THEM STEP BY STEP.**

## STEP 1

**ATTACH CAMLOCK PIN (E) AND WOOD DOWEL (G) TO LEG  
PANEL (A) AS SHOWN.**

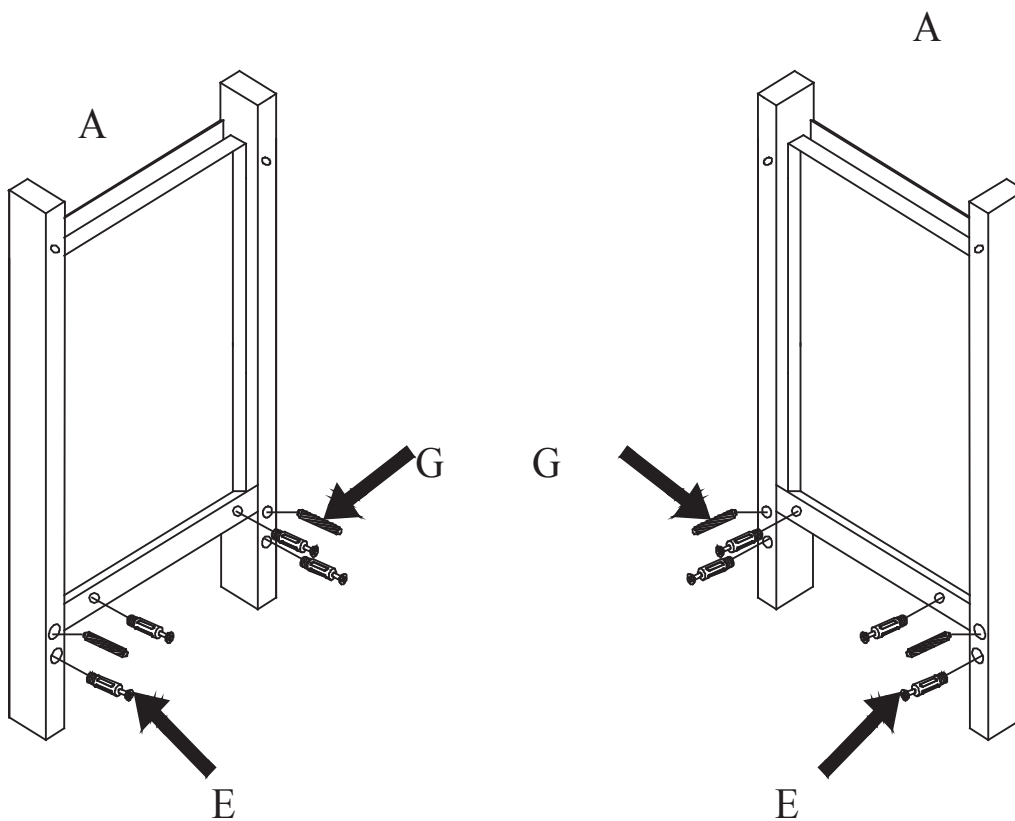

## STEP 2

**2.1 ATTACH CAMLOCK (F) TO THE HOLES OF BOTTOM PANEL (B) AND SIDE PANEL (C) AS SHOWN.**

**2.2 ATTACH SIDE PANEL (C) TO BOTTOM PANEL (B) USING CAMLOCK PIN (E) AS SHOWN.**

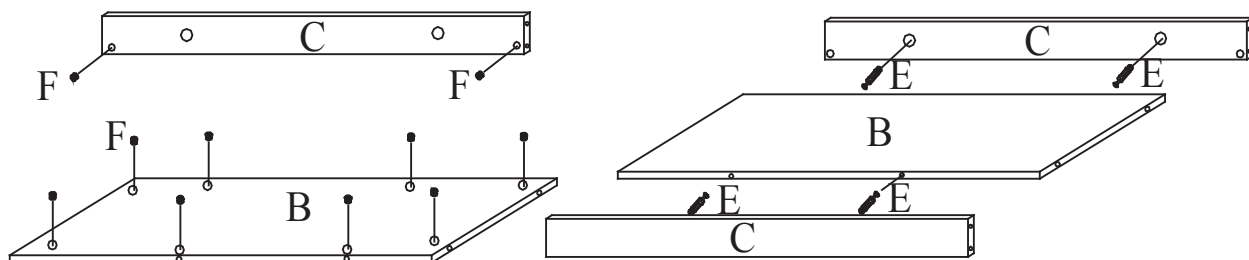

## STEP 3

**ATTACH LEG PANEL (A) TO BOTTOM PANEL (B) AND SIDE PANEL (C) USING CAMLOCK PIN (E) AND WOOD DOWEL (G) AS SHOWN.**

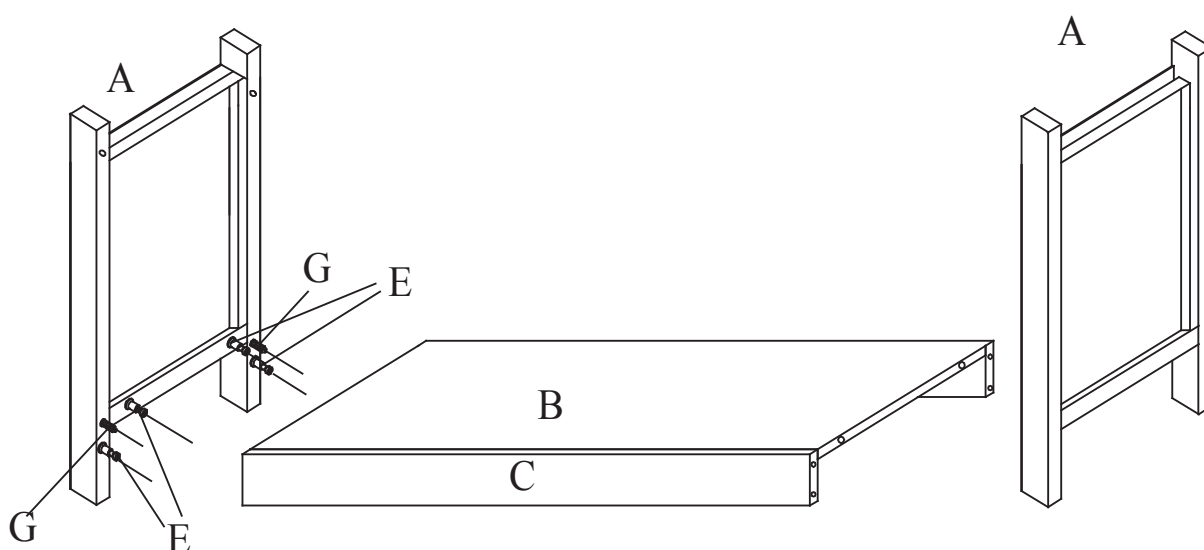

**STEP 4**

**ATTACH TOP PANEL WITH DRAWER (D) TO LEG PANEL (A) USING BOLT (H), WASHER (K) AND ALLEN WRENCH (L) AS SHOWN.**

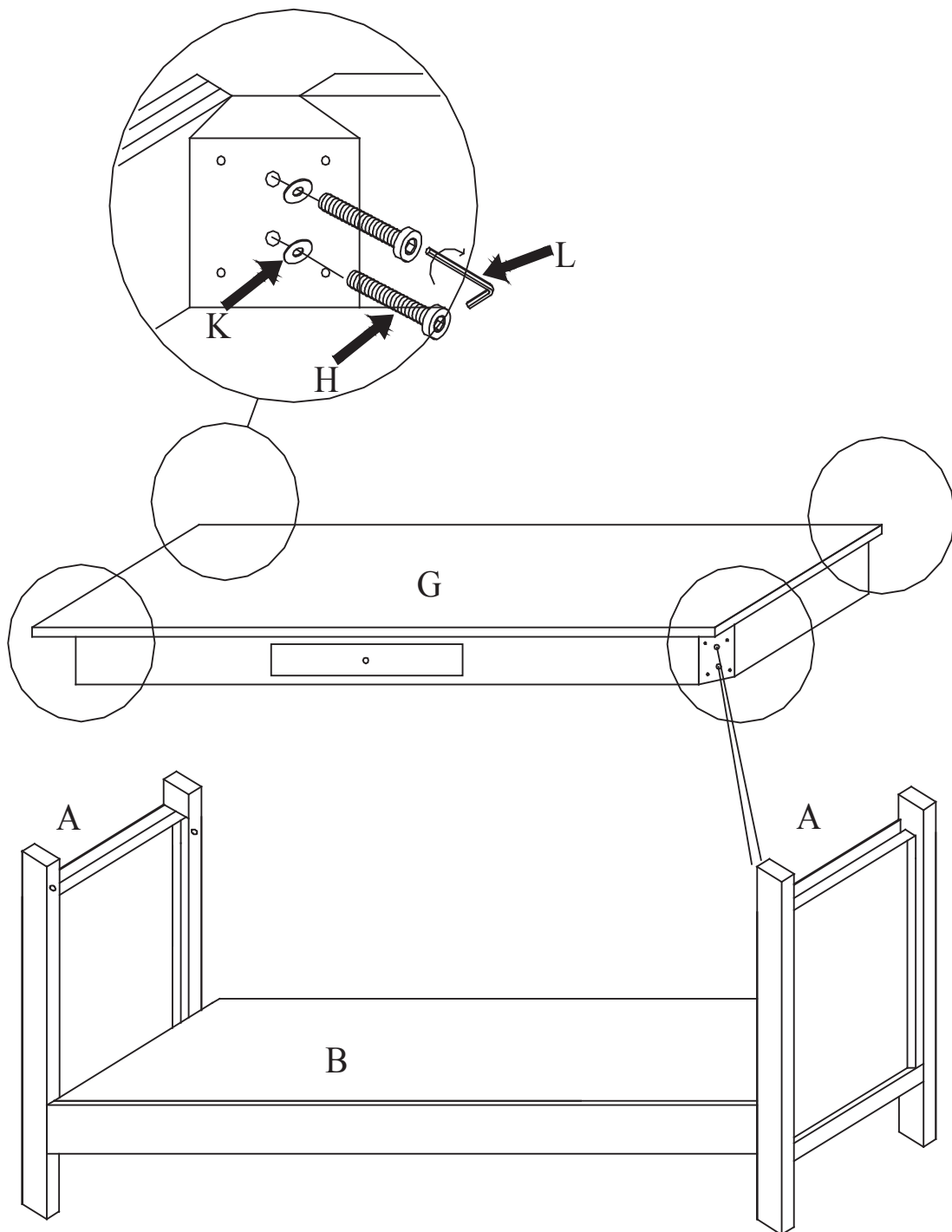

## STEP 5

**ATTACH KNOB (J) TO THE DRAWER OF TOP PANEL (D) USING SCREW (I) AS SHOWN.**

**\*IN ORDER TO AVOID THE TILTING ISSUES, YOU CAN USE THE PROVIDED METAL PLATE (M), SHORT SCREW (N), PLASTIC NUT (O) AND LONG SCREW (P) TO FIX THIS PRODUCT ON THE WALL AS SHOWN.\***

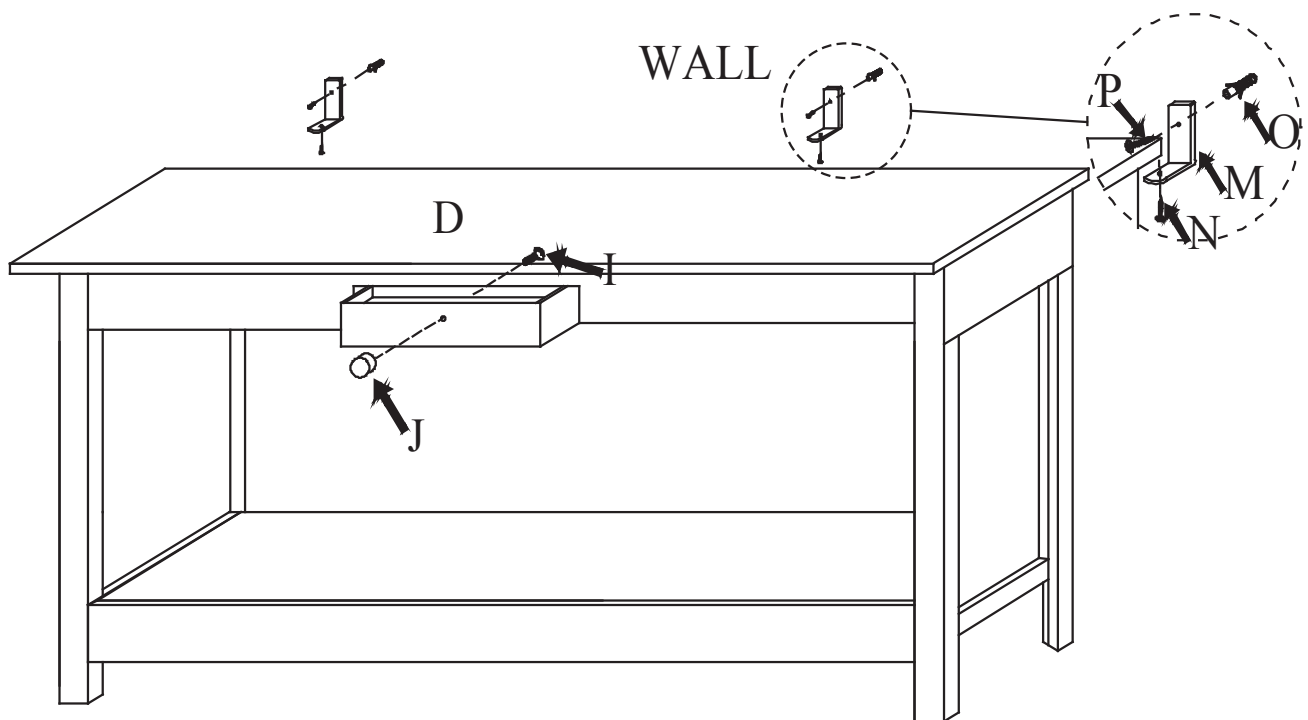

Do you have any questions? Missing small parts or hardware?

If you need assistance with the assembly of your CONSOLE  
TABLE WITH DRAWER please e-mail our Customer Service

Department at: [support@fourstari.com](mailto:support@fourstari.com)

or call us at (508) 435-4830

or (800) 639-3803

Please include the following information in your email:

- Where item was purchased
- Item, model, style or SKU number listed on instructions or box
- Part number, description of the part and quantity needed

This information will help us get the proper part to you faster