

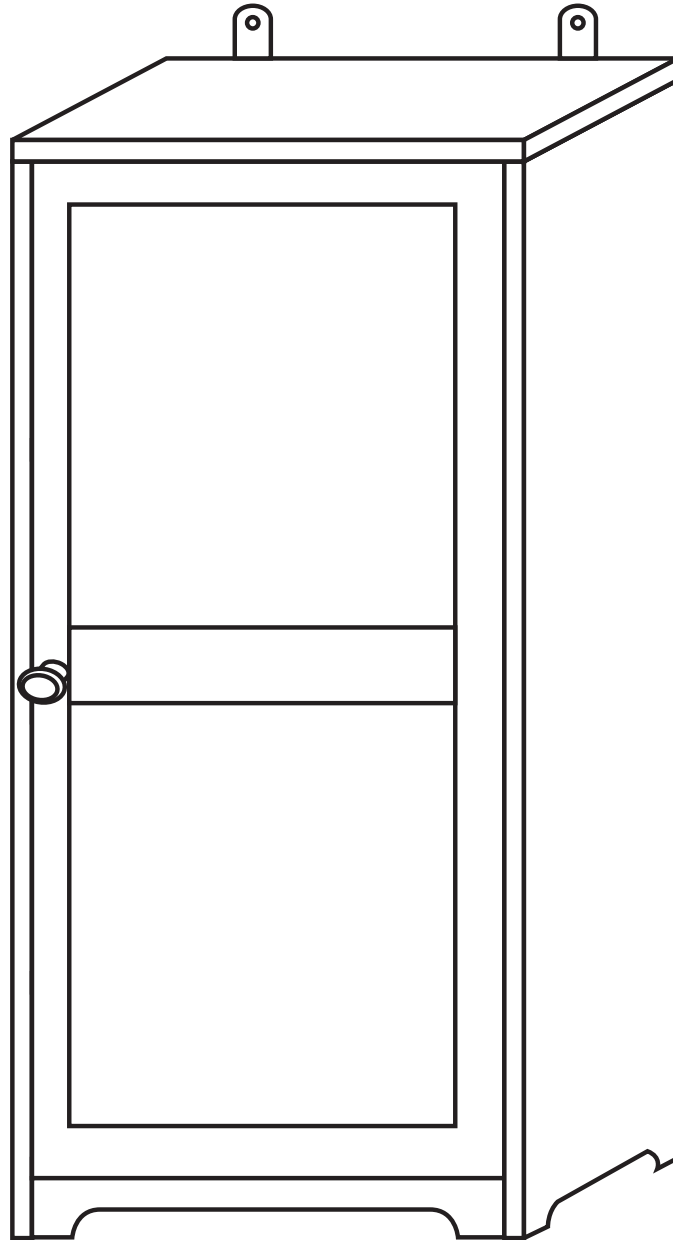

fourstargroup











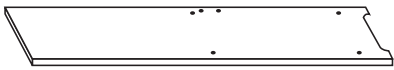
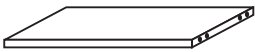
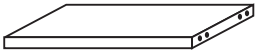
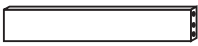

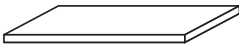
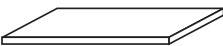
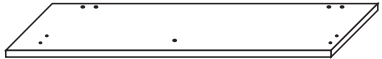
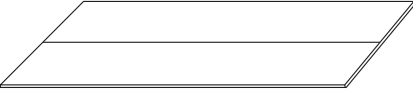



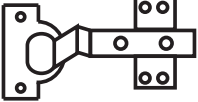



MODEL: 11221028V

CABINET WITH DOOR
ARMARIO CON PUERTA

PARTS LIST AND HARDWARE

LISTA DE PARTES Y ACCESORIOS

| | | | |
|---|---|---|----------------|
| A |  | SIDE PANEL PANEL LATERAL | 2PCS 2PZS |
| B |  | FIXED PANEL PANEL FIJO | 1PC 1PZ |
| C |  | FIXED PANEL PANEL FIJO | 1PC 1PZ |
| D |  | MIDDLE RAIL CARRIL MEDIO | 1PC 1PZ |
| E |  | BASE RAIL CARRIL BASE | 1PC 1PZ |
| F |  | TOP PANEL PANEL SUPERIOR | 1PC 1PZ |
| G |  | ADJUSTABLE PANEL PANEL AJUSTABLE | 2PCS 2PZS |
| H |  | DOOR PUERTA | 1PC 1PZ |
| I |  | BACK PANEL PANEL TRASERO | 1PC 1PZ |
| J |  | WOODEN DOWEL CLAVIJA DE MADERA | 18PCS 18PZS |
| K |  | LONG SCREW TORNILLO LARGO | 12PCS 12PZS |
| L |  | METAL DOWEL AND CAM LOCK CLAVIJA METAL Y CERRADURA | 4SETS 4SETS |
| M |  | HINGE BISAGRA | 2PCS 2PZS |

| | | | |
|---|---|---------------------------------------|----------------|
| N |  | SCREW TORNILLO | 12PCS 12PZS |
| O |  | HANDLE MANIJA | 1PC 1PZ |
| P |  | SUPPORT HARDWARE SOPORTE ACCESORIO | 8PCS 8PZS |
| Q |  | MAGNET IMAN | 2SETS 2SETS |
| R |  | MAGNET PLATE PARCHE DE HIERRO | 2PCS 2PZS |
| S |  | WALL BRACKET PARCHE DE HIERRO | 2PCS 2PZS |
| T |  | WALL ANCHOR TARUGO DE PARED | 2PCS 2PZS |
| U |  | SCREW TORNILLO | 2PCS 2PZS |
| V |  | FOOT PIN CLAVO CON PIE | 4PCS 4PZS |
| W |  | NAIL CLAVO | 26PCS 26PZS |
| X |  | PAPER COVER CUBIERTA DE PAPEL | 1SETS 1SETS |

CAUTION:

- 1. READ THIS INSTRUCTION MANUAL BEFORE YOU ASSEMBLE.**
- 2. ASSEMBLE ON SOFT SURFACE TO PREVENT DAMAGE TO FINISH OF CABINET WITH DOOR.**

ASSEMBLY TOOLS REQUIRED: PHILLIPS SCREWDRIVER (NOT PROVIDED)

PRECAUCIÓN:

- 1. LEA ESTE MANUAL COMPLETO ANTES DE ARMAR ESTE PRODUCTO.**
- 2. ENSAMBLELO SOBRE SUPERFICIES SUAVES PARA EVITAR DAÑAR EL ACABADO DEL PRODUCTO.**

HERRAMIENTAS DE MONTAJE REQUERIDAS: DESTORNILLADOR PHILLIPS (NO PROVEIDO)

ASSEMBLY INSTRUCTIONS INSTRUCCIONES DE MONTAJE

STEP 1

ATTACH SIDE PANEL (A) TO FIXED PANEL (B), FIXED BOTTOM PANEL (C), MIDDLE RAIL (D), BASE RAIL (E) WITH WOOD DOWELS (J) AND LONG SCREWS (K) AS SHOWN. THEN ATTACH PAPER COVER (X) AND FOOT PIN (V) AS SHOWN.

PASO 1

ADJUNTE EL PANEL LATERAL (A) AL PANEL FIJO (B), PANEL FIJO INFERIOR (C), CARRIL MEDIO (D), CON LAS CLAVIJAS DE MADERA (J) Y LOS TORNILLOS LARGOS (K) COMO SE MUESTRA. LUEGO ADJUNTE LA CUBIERTA DE PAPEL (X) Y LOS PIE CON CLAVO (V) COMO SE MUESTRA.

STEP 2

ATTACH STEP 1 FINISHED PART TO TOP PANEL (F) WITH WOODEN DOWEL (J) METAL DOWEL AND CAM LOCK (L) USING PHILLIPS SCREWDRIVER AS SHOWN.

PASO 2

ADJUNTE EL PASO 1 TERMINADO AL PANEL SUPERIOR (F) CON CLAVIJAS DE MADERA (J), CLAVIJA METAL Y CERRADURA (L) UTILIZANDO EL DESTORNILLADOR PHILLIPS COMO SE MUESTRA.

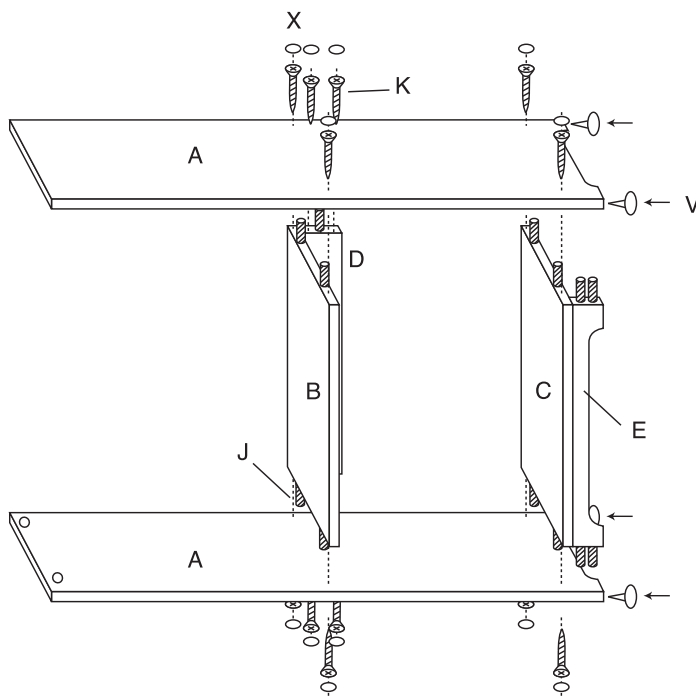

(STEP 1/PASO 1)

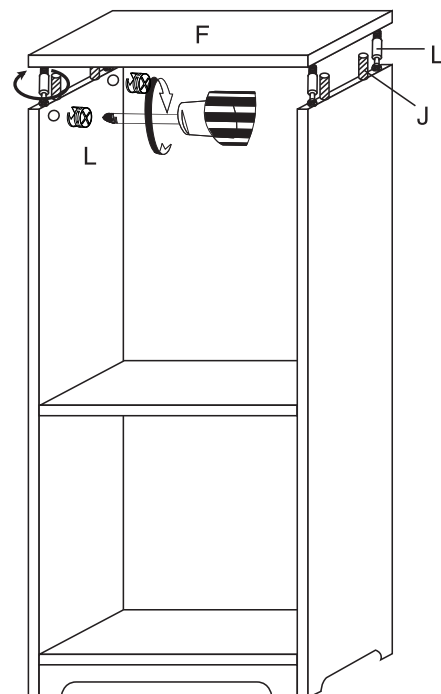

(STEP 2/PASO 2)

STEP 3

ATTACH MAGNET (Q) AND TO STEP (2) FINISHED PART USING PHILIPS SCREWDRIVER, ATTACH SUPPORT (P) AND INSERT THE ADJUSTABLE PANEL (G), THEN ATTACH THE DOOR TO STEP (2) FINISHED PART WITH HINGES (M) AND SCREWS (N) USING PHILIPS SCREWDRIVER, THEN ATTACH HANDLE AS SHOWN.

PASO 3

ADJUNTE EL IMAN (Q) AL PASO (2) TERMINADO UTILIZANDO EL DESTORNILLADOR PHILIPS, ADJUNTE EL SOPORTE (P) E INSERTE EL PANEL AJUSTABLE (G), Y LUEGO ADJUNTE LA PUERTA AL PASO (2) TERMINADO CON LAS BISAGRAS (M) Y TORNILLOS (N) UTILIZANDO EL DESTORNILLADOR PHILIPS, POR ULTIMO ADJUNTE LA MANIJA COMO SE MUESTRA.

STEP 4

ATTACH BACK PANEL (I) TO STEP (3) FINISHED PART WITH NAILS (W), ATTACH WALL BRACKET (S) AS SHOWN, THEN ATTACH THE CABINET TO THE WALL USING THE ANCHORS AND SCREWS WITH THE WALL BRACKETS AS SHOWN.

PASO 4

ADJUNTE EL PANEL TRASERO (I) AL PASO (3) TERMINADO CON TORNILLOS (W), ADJUNTE LOS PARCHES DE METAL (S) COMO SE MUESTRA, LUEGO ADJUNTE EL TARUGO DE PARED (T) A LA PARED CON TORNILLOS (U) COMO SE MUESTRA.

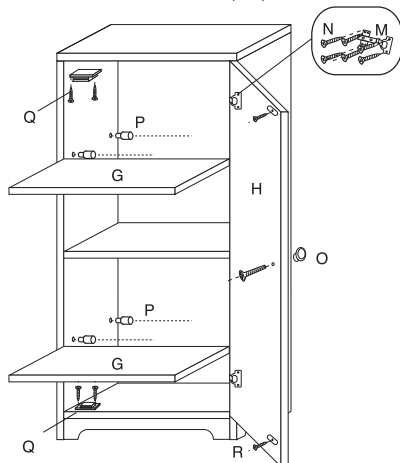

(STEP 3/PASO 3)

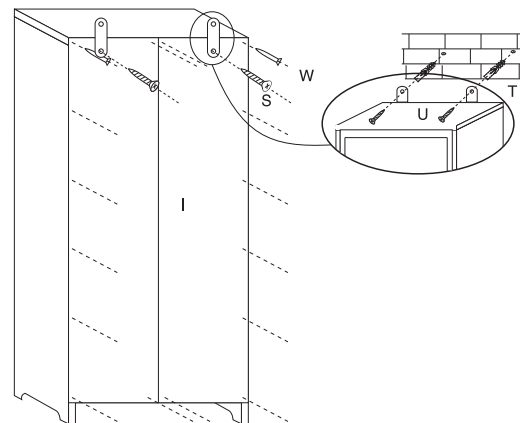

(STEP 4/PASO 4)

Do you have any questions? Missing small parts or hardware?
If you need assistance with the assembly of your CABINET WITH DOOR
please e-mail our Customer Service Department at: support@fourstari.com
or call us at (508) 435-4830 or (800) 639-3803

Please include the following information in your email:

- Where item was purchased
- Item, model, style or SKU number listed on instructions or box
- Part number, description of the part and quantity needed

This information will help us get the proper part to you faster

¿Tiene alguna pregunta? ¿Faltan piezas o accesorios pequeños?

Si necesita ayuda para ensamblar su ARMARIO CON PUERTA
envíenos un correo electrónico a nuestro Departamento de atención al cliente:
support@fourstari.com o llámenos al (508) 435-4830 o al (800) 639-3803

Incluya la siguiente información en el correo electrónico:

- Dónde compró el producto
- El número de SKU, estilo, modelo o producto que aparece en las instrucciones o la caja
- El número y descripción de la pieza y la cantidad que necesita

Esta información nos ayudará a enviarle la pieza correcta con mayor rapidez