

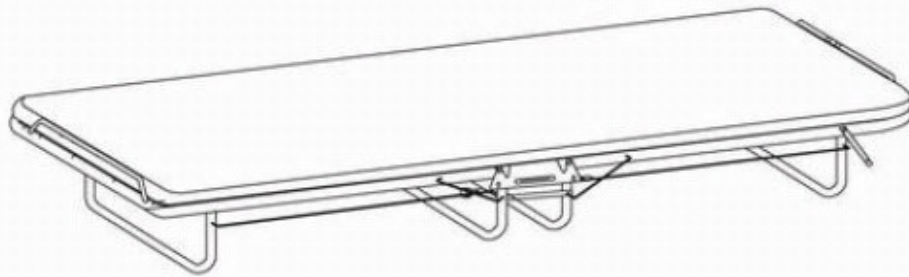







fourstargroup



MODEL: 11220770F

FOLDING BED

PARTS LIST AND HARDWARE

A		BED FRAME	1PC
B		MATTRESS	1PC
C		CASTOR	4PCS
D		NUT	4PCS
E		WRENCH	1PC

BEFORE YOU BEGIN, PLEASE READ ASSEMBLY INSTRUCTIONS CAREFULLY. FOLLOW THEM STEP BY STEP.

CAUTION :

- 1. ADULT SUPERVISION IS REQUIRED DUE TO SMALL PARTS. CARE SHOULD BE TAKEN IN THE UNPACKING AND ASSEMBLY OF THE PRODUCT.**
- 2. ASSEMBLE ON SOFT SURFACES TO PREVENT DAMAGE TO THE PRODUCT FINISH.**
- 3. MAKE SURE ALL PARTS ARE INCLUDED BEFORE ASSEMBLY.**

ASSEMBLY INSTRUCTIONS

STEP 1.1 ATTACH CASTORS (C) TO BED FRAME (A) USING NUTS (D) AND WREACH (E) AS SHOWN.

1.2 OPEN THE SAFETY LOCK ON THE TOP AND SIDE AS SHOWN.

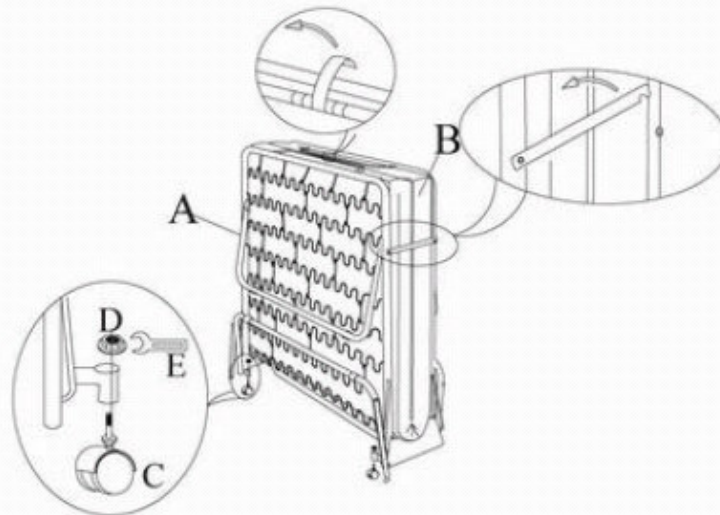

STEP 2

UNFOLD MATTRESS (B) AND BED FRAME (A) AS SHOWN, AND LOCK THE CENTRAL LEG AS SHOWN.

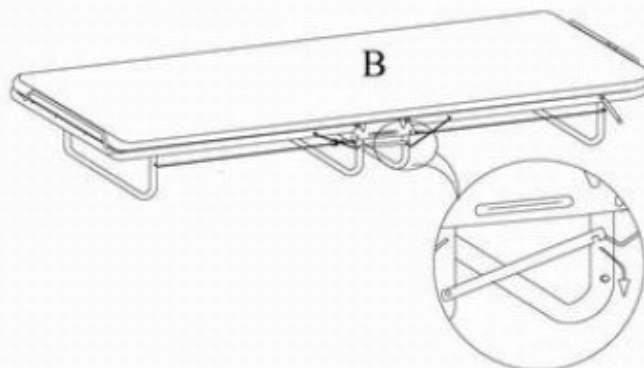

Warnings and Cautions:

- Adult supervision required for assembly, unfolding and set up.
- Read all assembly instructions, cautions and warnings before use.
- Insure center leg supports are engaged (right and left sides), before use.
- For use by only one (1) person at a time, not to exceed 225lbs.
- Not for use by toddlers, infants or babies.
- Do no stand, kneel, jump or play on folding bed.
- Do not allow children to play on, around or under folding bed.
- Product is designed for temporary use.
- Fold, lock and latch the folding bed when not in use.
- Inspect regularly to insure folding bed, frame or springs are in proper working order and condition.
- Do not use folding bed if damaged.
- Please recycle cardboard box.
- The polybag film wrapping is a packaging material only, it is not a toy and should be disposed of properly:

WARNING:

TO AVOID DANGER OF SUFFOCATION, KEEP THE BAG AWAY FROM BABIES AND SMALL CHILDREN.

Do you have any questions? Missing small parts or hardware?
If you need assistance with the assembly of your
FOLDING BED please e-mail our
Customer Service Department at:
support@fourstari.com
or call us at (508) 435-4830
or (800) 639-3803

Please include the following information in your email:

- Where item was purchased
- Item, model, style or SKU number listed on instructions or box
- Part number, description of the part and quantity needed

This information will help us get the proper part to you faster