







fourstargroup



MODEL: 11218221 FL

**WOODEN ORGANIZER
WITH STORAGE BINS**

PARTS AND HARDWARE

A.	SIDE FRAME (2 PCS)	
B.	TOP PANEL (1 PC)	
C.	SHELF (2 PCS)	
D.	SCREW (12 PCS)	
E.	BIN (2 PCS)	

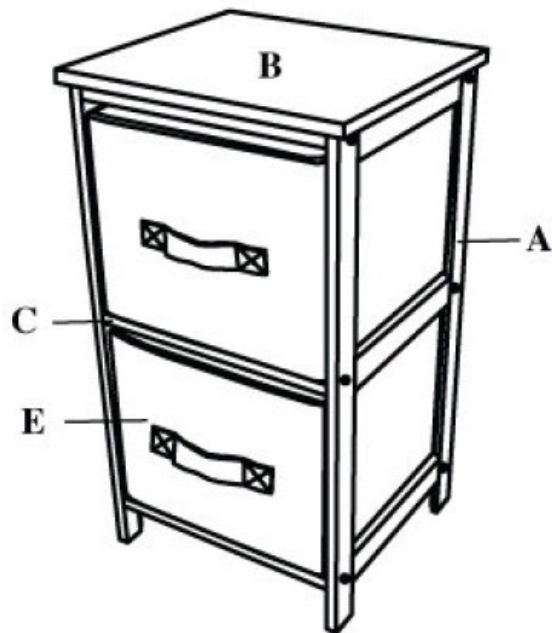

BEFORE YOU BEGIN, PLEASE READ ASSEMBLY INSTRUCTIONS CAREFULLY. FOLLOW THEM STEP BY STEP.

CAUTION :

- 1. ADULT SUPERVISION IS REQUIRED DUE TO SMALL PARTS. CARE SHOULD BE TAKEN IN THE UNPACKING AND ASSEMBLY OF THE PRODUCT.**
- 2. ASSEMBLE ON SOFT SURFACES TO PREVENT DAMAGE TO THE PRODUCT FINISH.**
- 3. MAKE SURE ALL PARTS ARE INCLUDED BEFORE ASSEMBLY.**

ASSEMBLY TOOLS REQUIRED :

**PHILIPS
SCREWDRIVER**



ASSEMBLY INSTRUCTIONS

STEP 1

ATTACH SIDE FRAMES (A) TO TOP PANEL (B) AND SHELVES (C)
USING SCREWS (D) AS SHOWN.

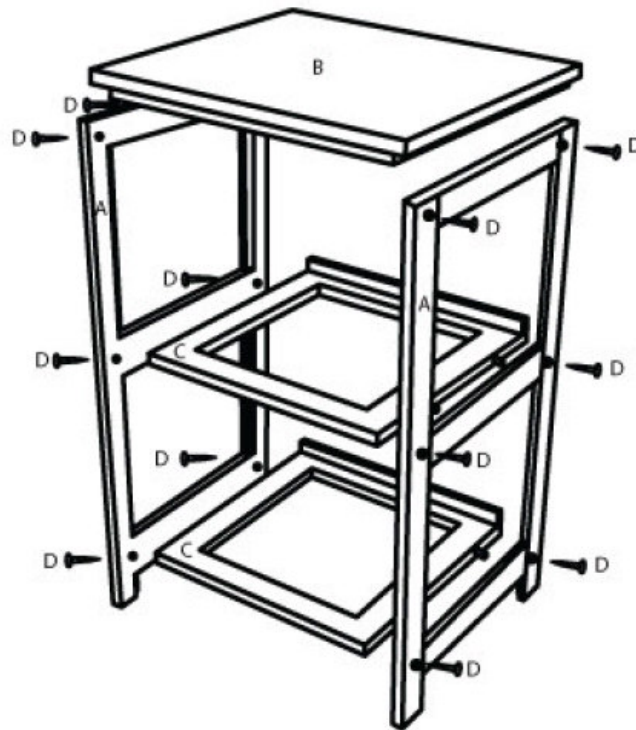

D. SCREW (12 PCS)

STEP 2
INSERT BINS (E) INTO SHELVES AS SHOWN.

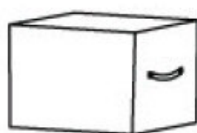

E. BIN (2 PCS)

MAXIMUM WEIGHT LIMIT 10 LBS.



This unit is intended for use only with the products and maximum weights indicated. Use with other products or products heavier than the maximum weights indicated may result in instability causing possible injury. Furniture can tip over or break if improperly moved. Have a friend help to lift and carry the unit to its new location.

Do you have any questions? Missing small parts or hardware?
If you need assistance with the assembly of your WOODEN ORGANIZER WITH STORAGE BINS please e-mail our Customer Service Department at:
support@fourstari.com
or call us at (508) 435-4830
or (800) 639-3803

Please include the following information in your email:

- Where item was purchased
- Item, model, style or SKU number listed on instructions or box
- Part number, description of the part and quantity needed

This information will help us get the proper part to you faster