

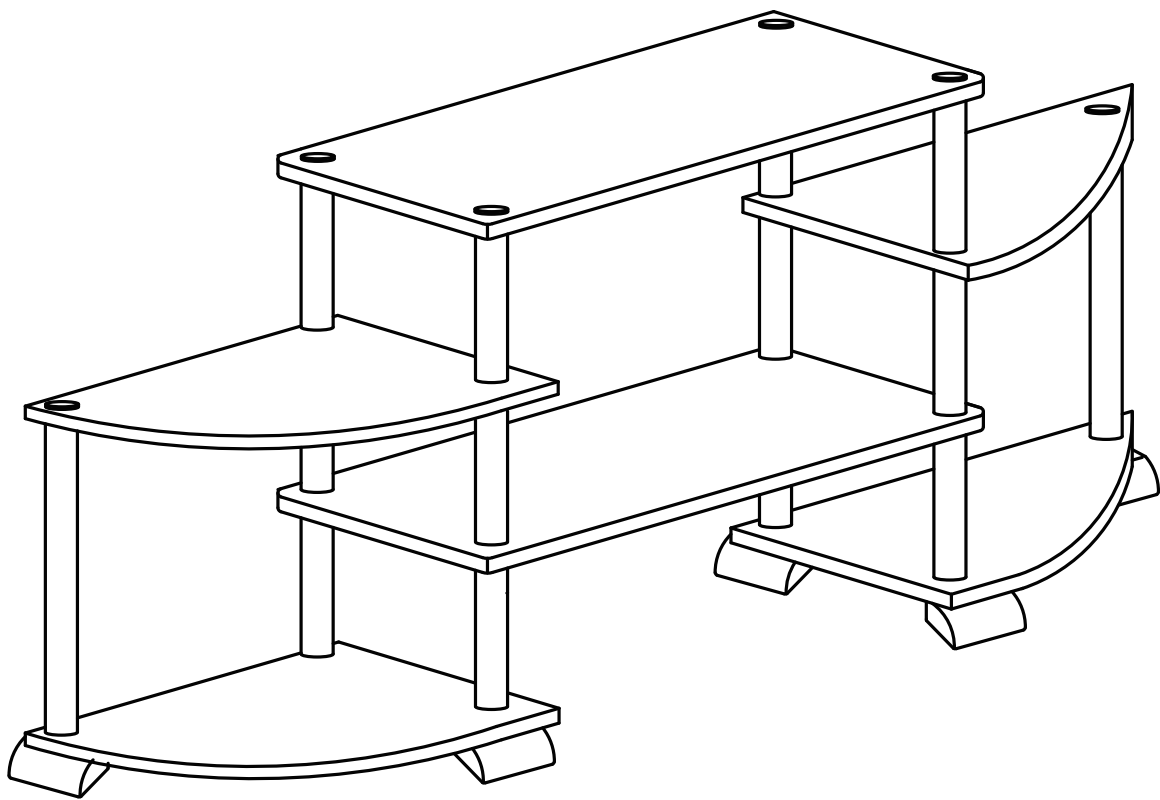









fourstargroup

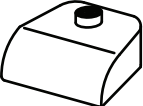

MODEL: 11211851

ENTERTAINMENT CENTER

PARTS AND HARDWARE

1	LONG POST (2 PCS)	
2	SHORT POST (12 PCS)	
3	CAP (6 PCS)	
4	NO-TIP FRONT FEET (6 PCS)	
A	CENTER SHELF PANEL (2 PCS)	
B	LEFT SIDE PANEL (2 PCS)	
C	RIGHT SIDE PANEL (2 PCS)	

BEFORE YOU BEGIN, PLEASE READ ASSEMBLY INSTRUCTIONS CAREFULLY. FOLLOW THEM STEP BY STEP.

CAUTION :

- 1. ADULT SUPERVISION IS REQUIRED DUE TO SMALL PARTS. CARE SHOULD BE TAKEN IN THE UNPACKING AND ASSEMBLY OF THE PRODUCT.**
- 2. ASSEMBLE ON SOFT SURFACES TO PREVENT DAMAGE TO THE PRODUCT FINISH.**
- 3. MAKE SURE ALL PARTS ARE INCLUDED BEFORE ASSEMBLY.**

ASSEMBLY INSTRUCTIONS

STEP 1

ATTACH 2 LONG POSTS (1), 4 SHORT POSTS (2), AND 6 NO-TIP FRONT FEET (4) TO 2 SIDE PANELS (B) AS SHOWN.

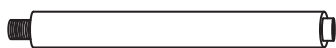
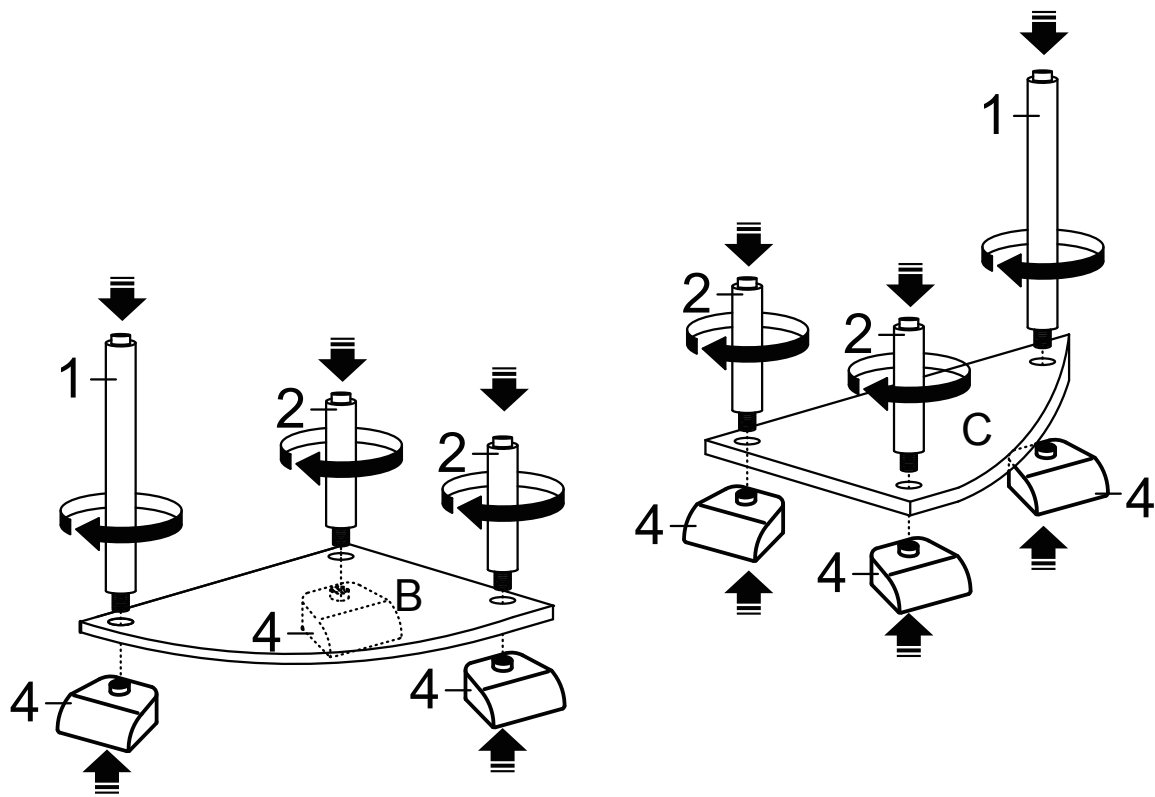

① LONG POST - 2 PCS

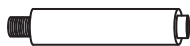

② SHORT POST - 4 PCS

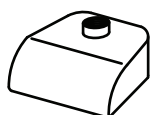

④ NO-TIP FRONT FEET - 6 PCS

STEP 2

ATTACH CENTER PANEL (A) AND 4 SHORT POSTS (2) TO ASSEMBLED STEP 1 AS SHOWN.

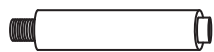
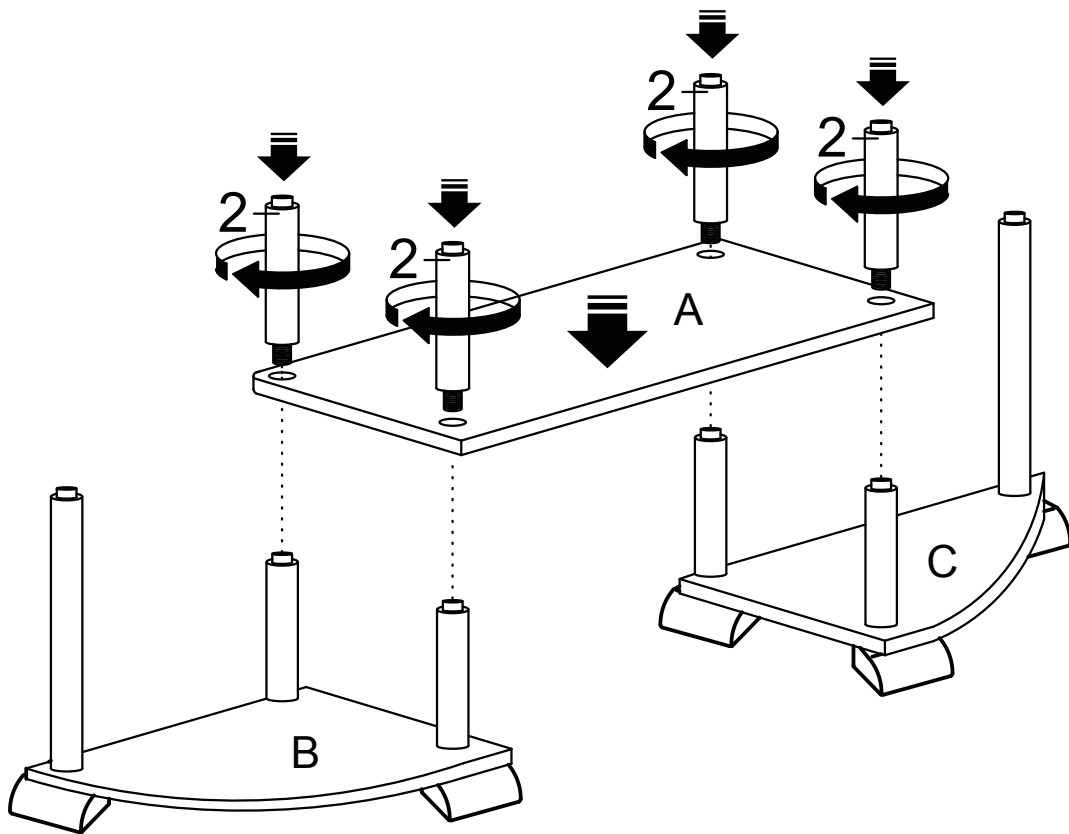

② SHORT POST - 4 PCS

STEP 3

ATTACH 2 SIDE PANELS (B) AND 4 SHORT POSTS (2) TO ASSEMBLED STEP 2 AS SHOWN.

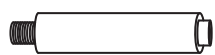
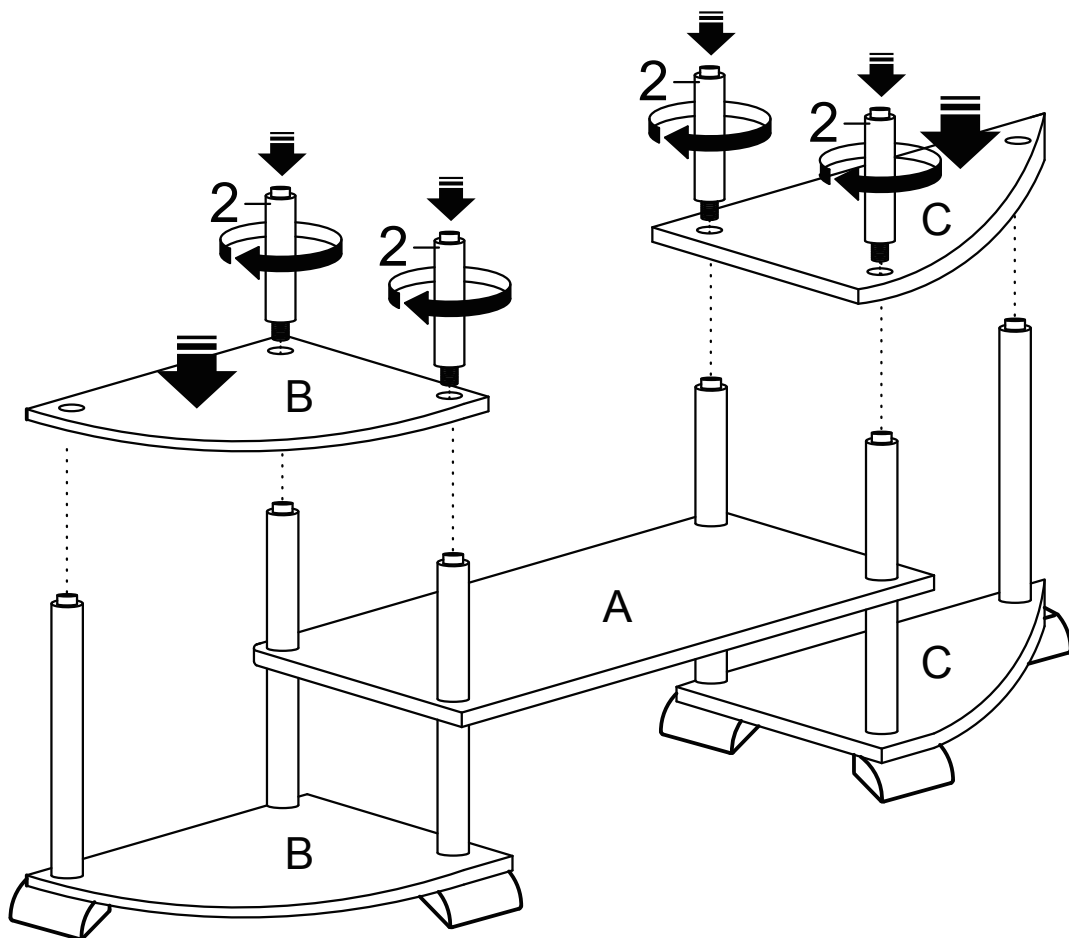

② SHORT POST - 4 PCS

STEP 4

ATTACH CENTER PANEL (A) AND 6 CAPS (3) TO ASSEMBLED STEP 3 AS SHOWN.

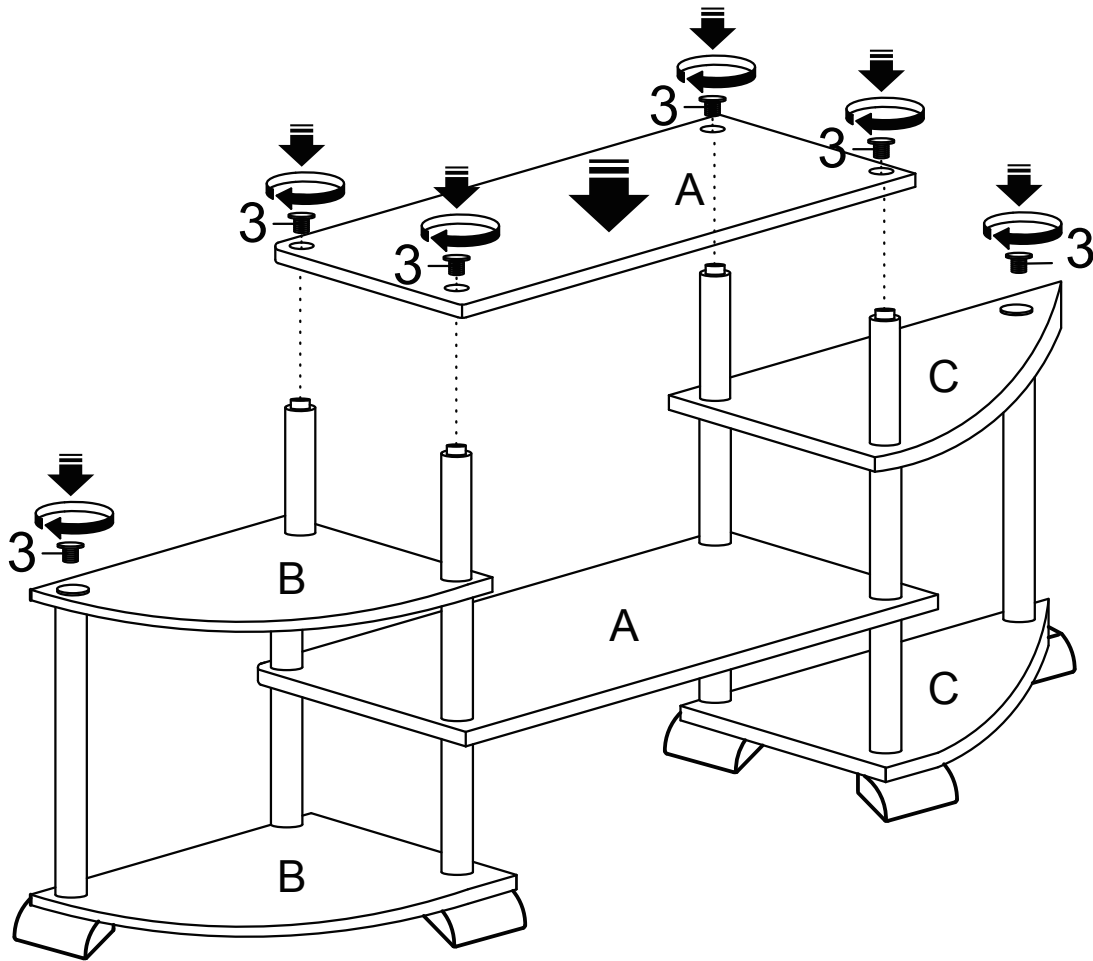

③ CAP - 6 PCS

Do you have any questions ? Missing small parts or hardware ?
If you need assistance with the assembly of your
ENTERTAINMENT CENTER please e-mail our
Customer Service Department at:
support@fourstari.com
or call us at **(508) 435-4830**
or (800) 639-3803

Please include the following information in your email:

- Where item was purchased
- Item, model, style or SKU number listed on instructions or box
- Part number, description of the part and quantity needed

This information will help us get the proper part to you faster