

Capacidad máxima del estante:
184 lbs. (83.4 kg)

Capacidad máxima del estante:
87 lbs. (39.4 kg)

Esta unidad está destinada sólo para su uso con los productos y pesos máximos indicados. Si usted utiliza esta mesa con otros productos o de los productos más pesados que el peso máximo indicado, puede causar inestabilidad y puede dar lugar a posibles lesiones. La mesa puede volcarse o romperse si es trasladada indebidamente. Se sugiere tener un amigo para que le ayude a levantar y transportar la mesa a su nueva ubicación.

¿Tiene alguna pregunta? ¿Faltan piezas o accesorios pequeños?

Si necesita ayuda para ensamblar su MESA DE CAFE

envíenos un correo electrónico a nuestro

Departamento de atención al cliente: ayuda@fourstari.com

o llámenos al (508) 435-4830

o al (800) 639-3803

Incluya la siguiente información en el correo electrónico:

- Dónde compró el producto
- El número de artículo, SKU, estilo, modelo o producto que aparece en las instrucciones o la caja
- El número y descripción de la pieza y la cantidad que necesita

Esta información nos ayudará a enviarle la pieza correcta con mayor rapidez





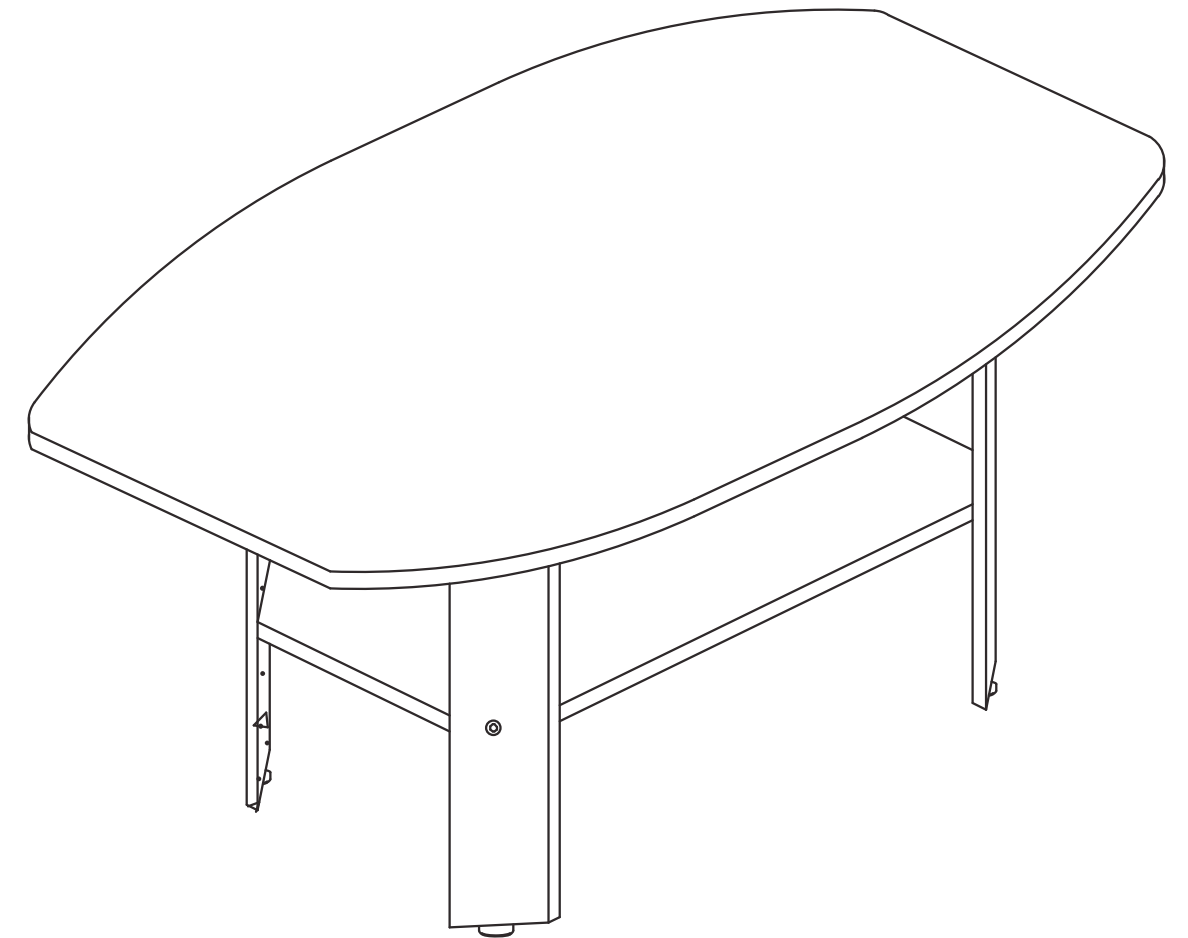



fourstargroup

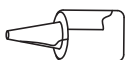

MODEL: 11211717P
COFFEE TABLE

PARTS LIST AND HARDWARE

NO	HARDWARE LIST	QTY
1	WOOD DOWEL 	8 PCS
2	C/B SCREW 	8 PCS
3	FURNITURE GLIDE 	4 PCS
4	WHITE GLUE 	1 PC
5	L-BRACKET 	4 PCS
6	TAPPING SCREW 	8 PCS

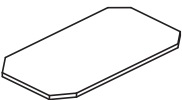
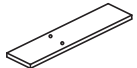
NO	HARDWARE LIST	QTY
A	TOP PANEL 	1 PC
B	SHELF PANEL 	1 PC
C	LEG PANEL 	4 PCS

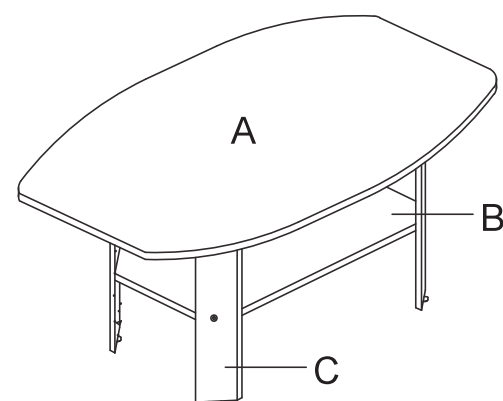

PASO #4

ADJUNTE EL ESTANTE (B) A LAS PATAS (C) USANDO LOS TORNILLOS C/B (2), COMO SE MUESTRA. LUEGO PERMITA QUE EL PEGAMENTO SE LLEGUE A SECAR COMPLETAMENTE.

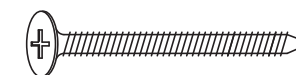
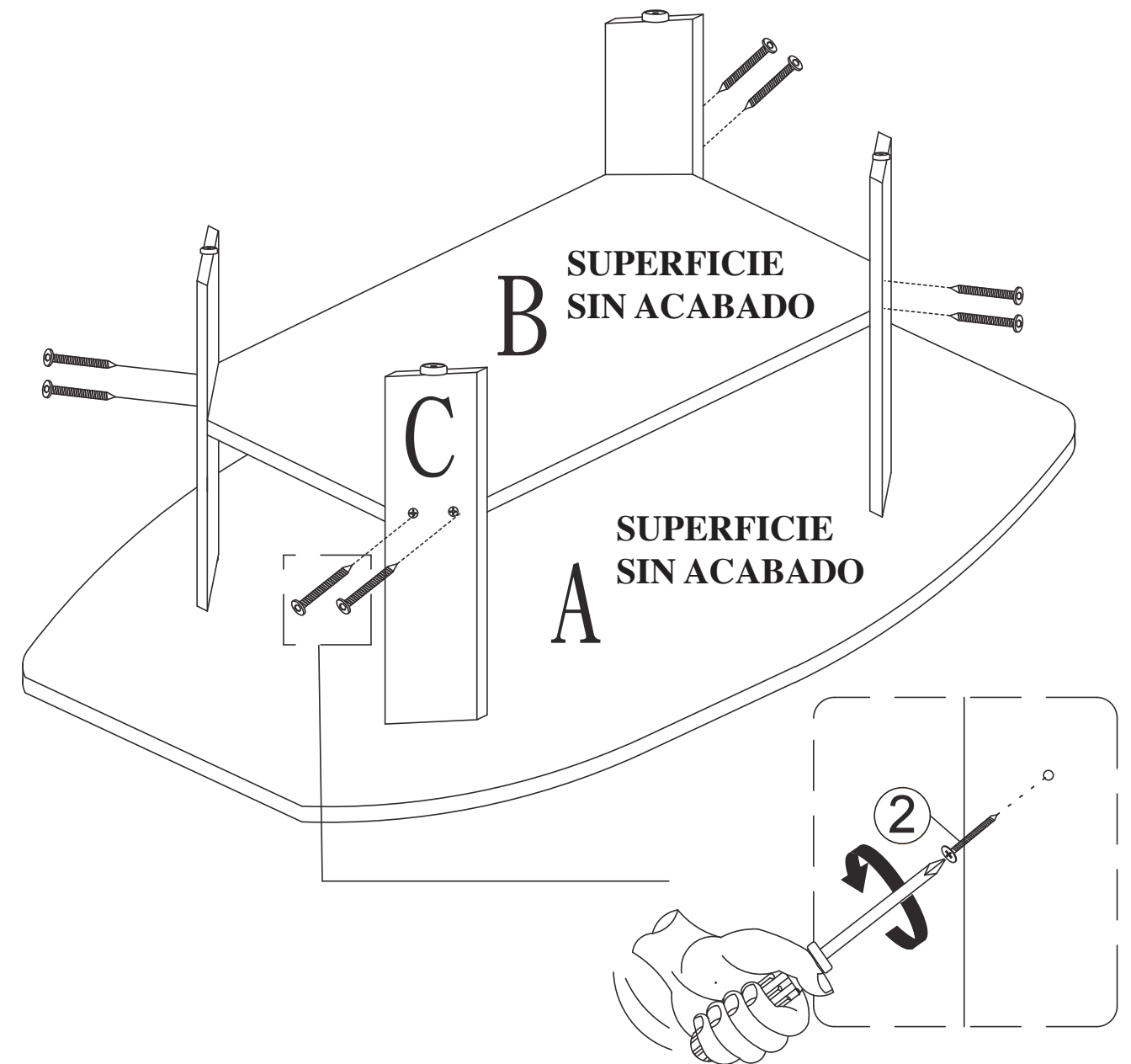

② TORNILLOS C/B – 8 PZS

PASO #3
ADJUNTE LOS TORNILLOS (6) A LOS SOPORTES (5), COMO SE MUESTRA.

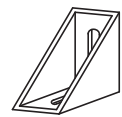
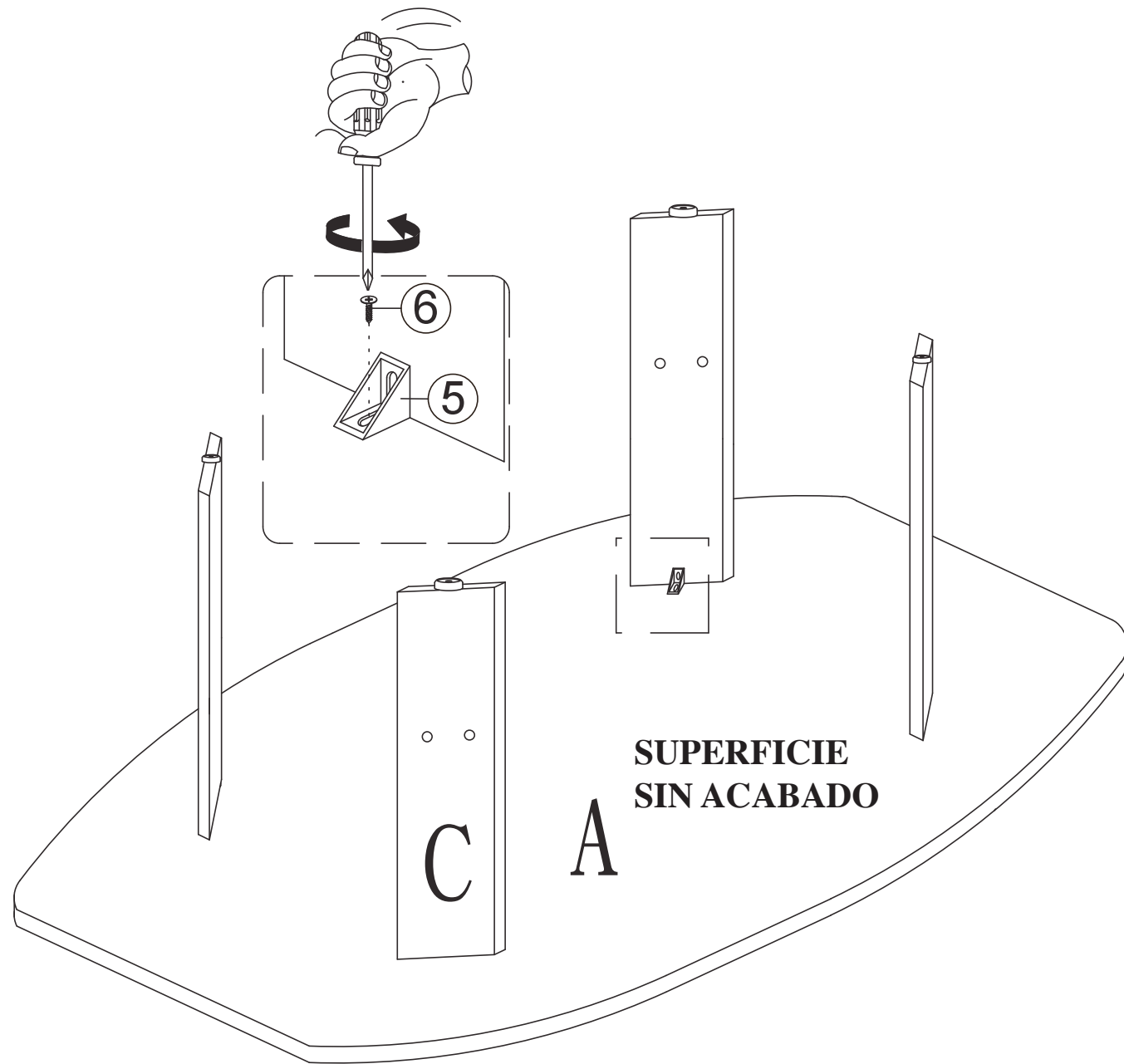

⑤ SOPORTE - 4 PZS



⑥ TORNILLOS - 4 PZS

BEFORE YOU BEGIN , PLEASE READ ASSEMBLY INSTRUCTIONS CAREFULLY. FOLLOW THEM STEP BY STEP.

CAUTION:

- 1. ADULT SUPERVISION IS REQUIRED DUE TO SMALL PARTS. CARE SHOULD BE TAKEN IN THE UNPACKING AND ASSEMBLY OF THE PRODUCT.**
- 2. ASSEMBLE ON SOFT SURFACES TO PREVENT DAMAGE TO THE PRODUCT FINISH.**
- 3. MAKE SURE ALL PARTS ARE INCLUDED BEFORE ASSEMBLY.**

ASSEMBLY TOOLS REQUIRED

PHILIPS SCREWDRIVER

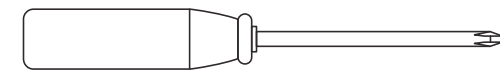

HAMMER

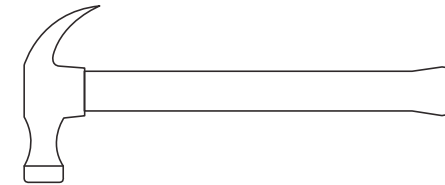

RUBBER MALLET

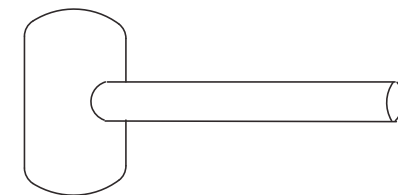

ASSEMBLY INSTRUCTIONS

STEP 1

ATTACH THE WOOD DOWELS (1) TO THE HOLES IN THE LEGS (C) USING THE GLUE (4), THEN ATTACH THE L-BRACKET (5) USING THE TAPPING SCREWS (6), AS SHOWN.

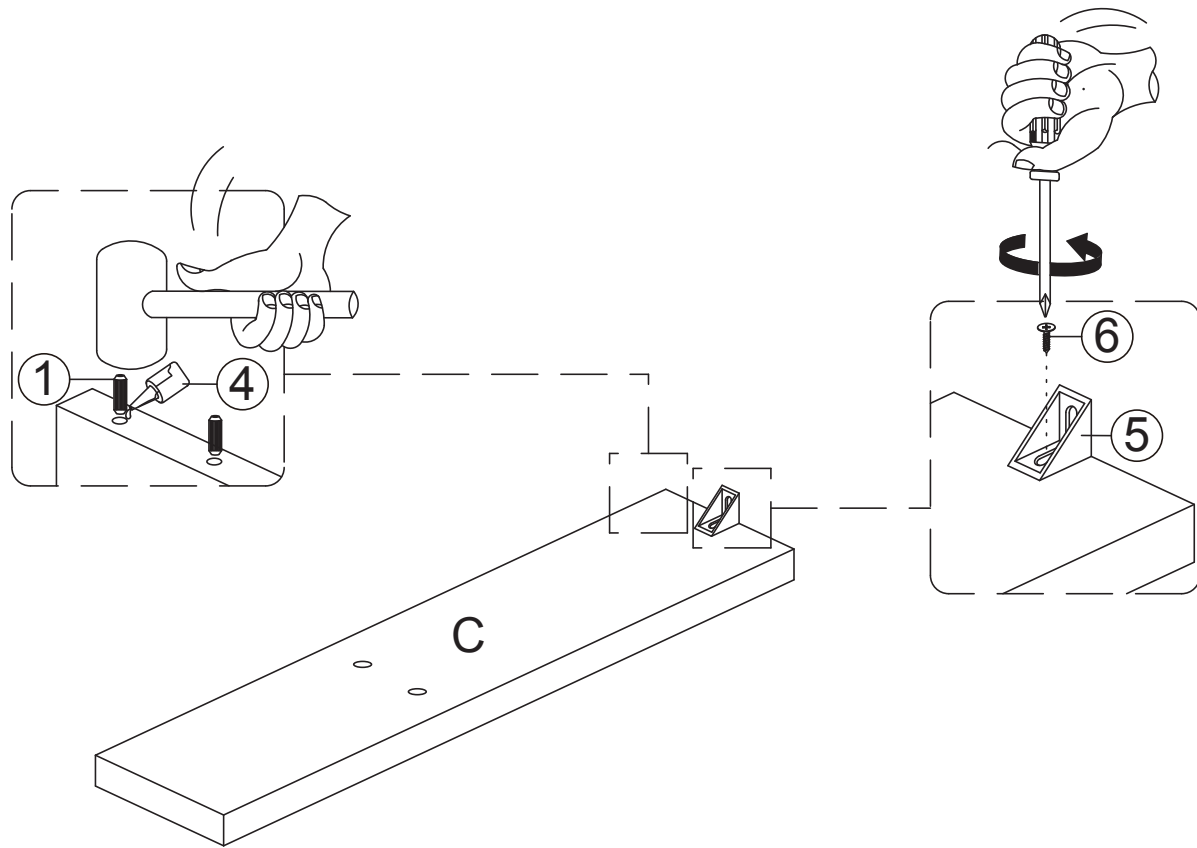

① WOOD DOWEL - 8 PCS

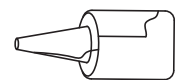

④ WHITE GLUE - 1 PC

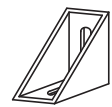

⑤ L-BRACKET - 4 PCS

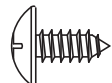

⑥ TAPPING SCREW - 4 PCS

PASO #2

ADJUNTE EL PANEL SUPERIOR (A) A LAS PARTES ASAMBLADAS DEL PASO # 1 USANDO LAS CLAVIJAS DE MADERA (1) Y EL PEGAMENTO (4), LUEGO ATA LOS DESLIZADORES (3) A LA BASE DE LAS PATAS (C), COMO SE MUESTRA.

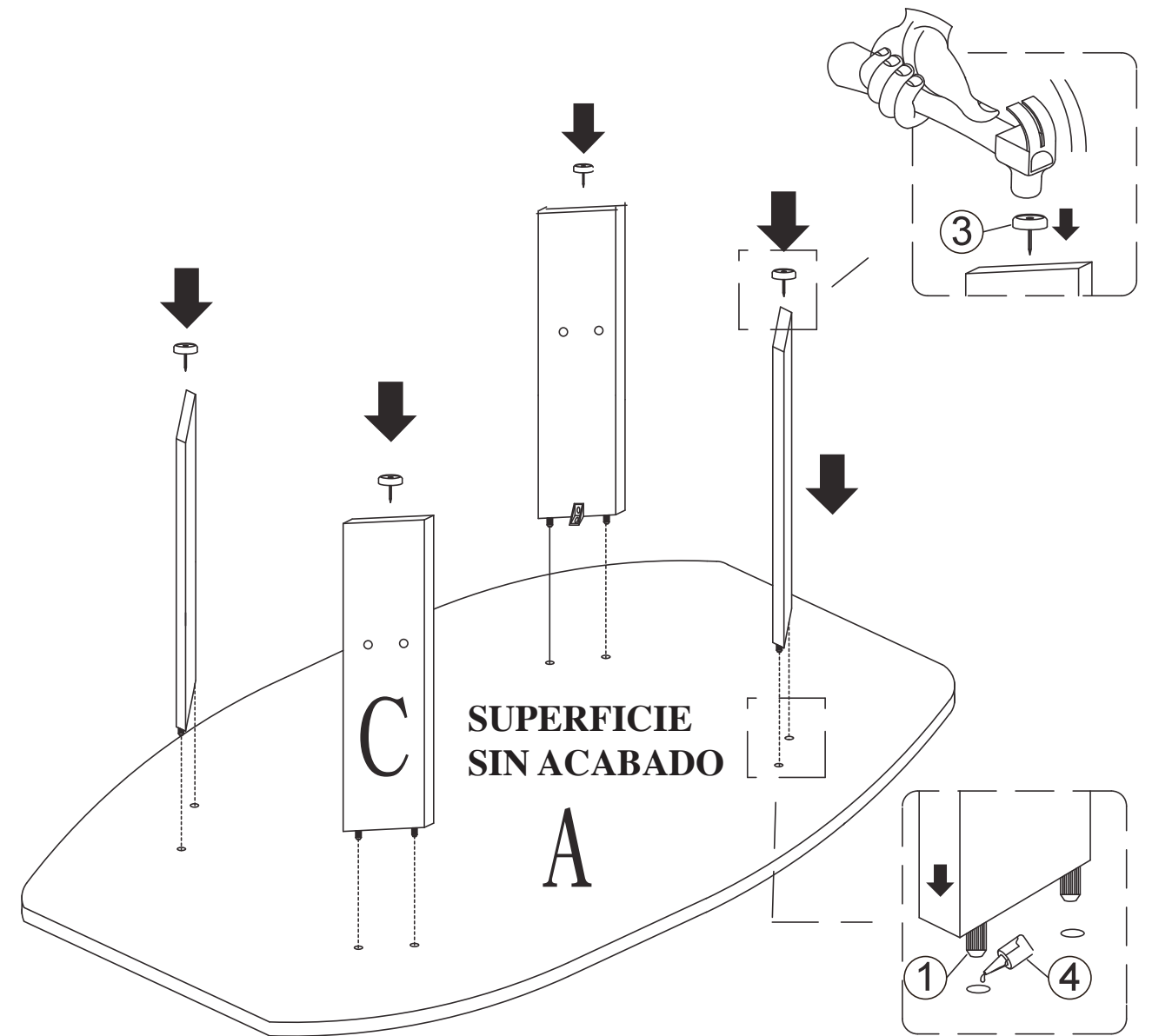

① CLAVIJAS DE MADERA - 8 PZS

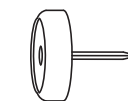

③ DESLIZADORES - 4 PZS

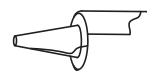

④ PEGAMENTO - 1 PZ

INSTRUCCIONES DE ASAMBLEA

PASO #1

INSERTE LAS CLAVIJAS DE MADERAS (1) DENTRO LOS AGUJEROS DE LAS PATAS (C) UTILIZANDO EL PEGAMENTO (4), LUEGO ADJUNTE EL SOPORTE (5) UTILIZANDO LOS TORNILLOS (6), COMO SE MUESTRA.

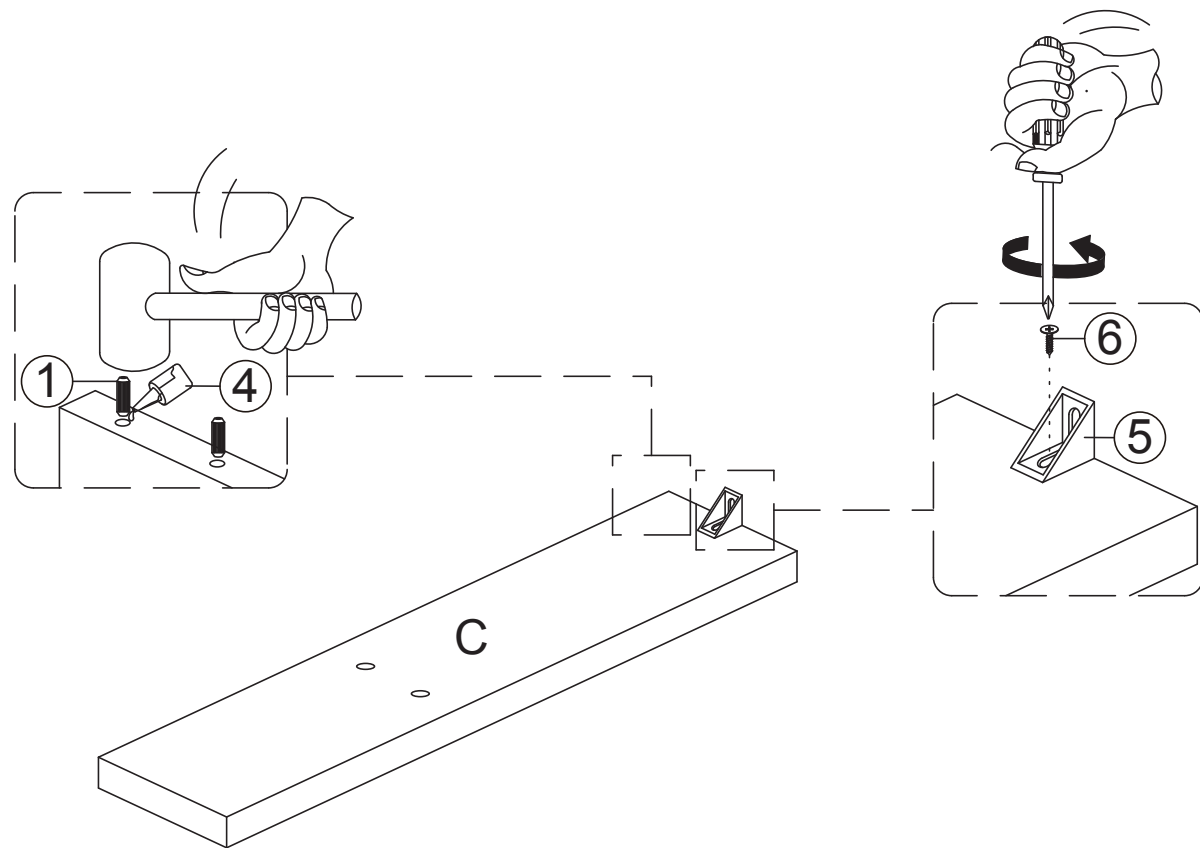

① CLAVIJAS DE MADERA - 8 PZS

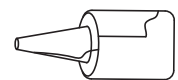

④ PEGAMENTO - 1 PZ

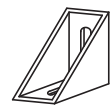

⑤ SOPORTE - 4 PZS

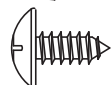

⑥ TORNILLOS - 4 PZS

STEP 2

ATTACH THE TOP PANEL (A) TO THE ASSEMBLED PARTS FROM STEP 1 USING THE WOOD DOWELS (1) AND WHITE GLUE (4), THEN ATTACH THE FURNITURE GLIDE (3) TO THE BASE OF THE LEGS (C), AS SHOWN.

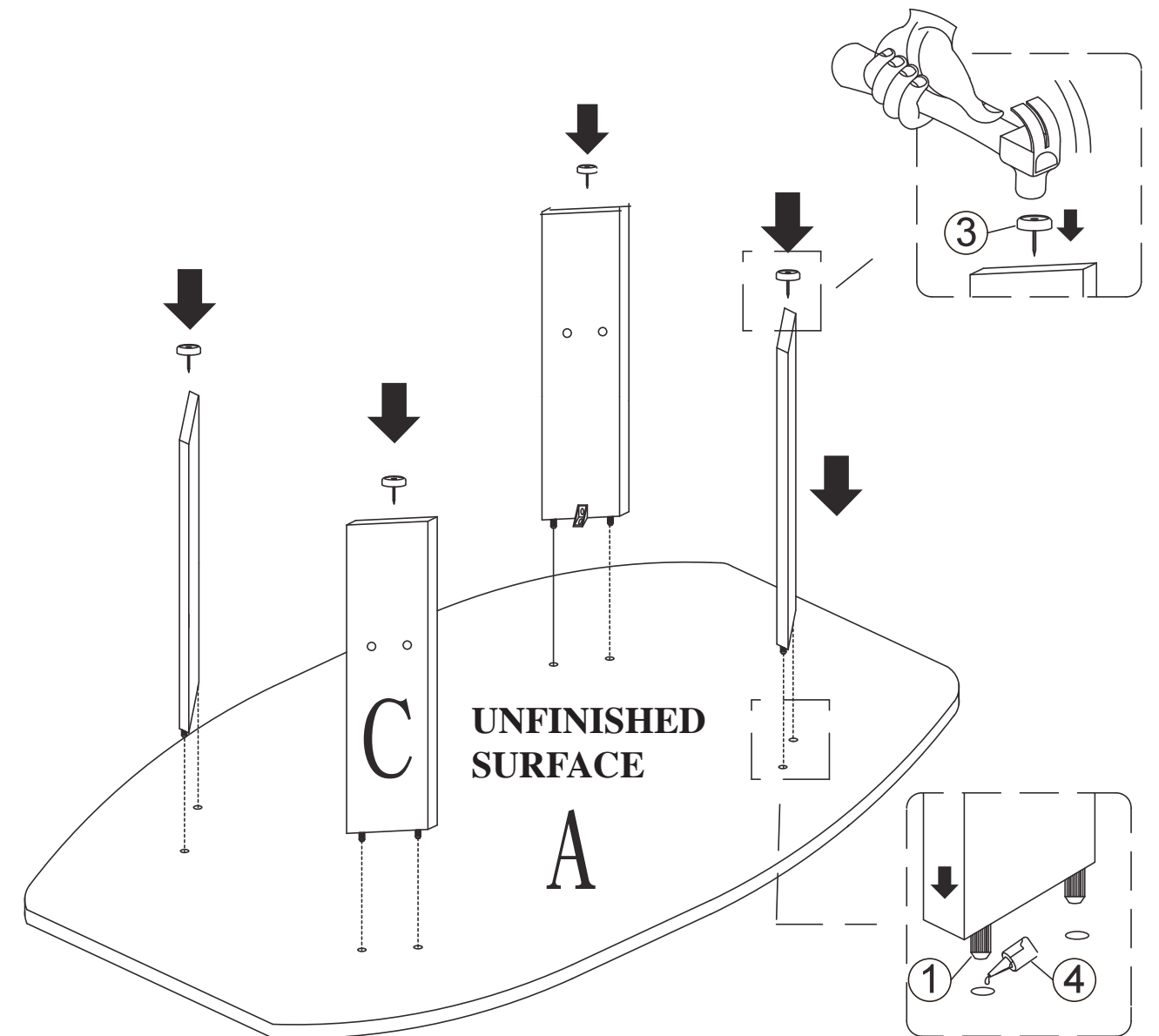

① WOOD DOWEL - 8 PCS

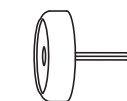

③ FURNITURE GLIDE - 4 PCS



④ WHITE GLUE - 1 PC

STEP 3
ATTACH TAPPING SCREWS (6) TO THE L-BRACKET (5) AS SHOWN.

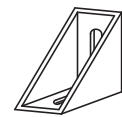
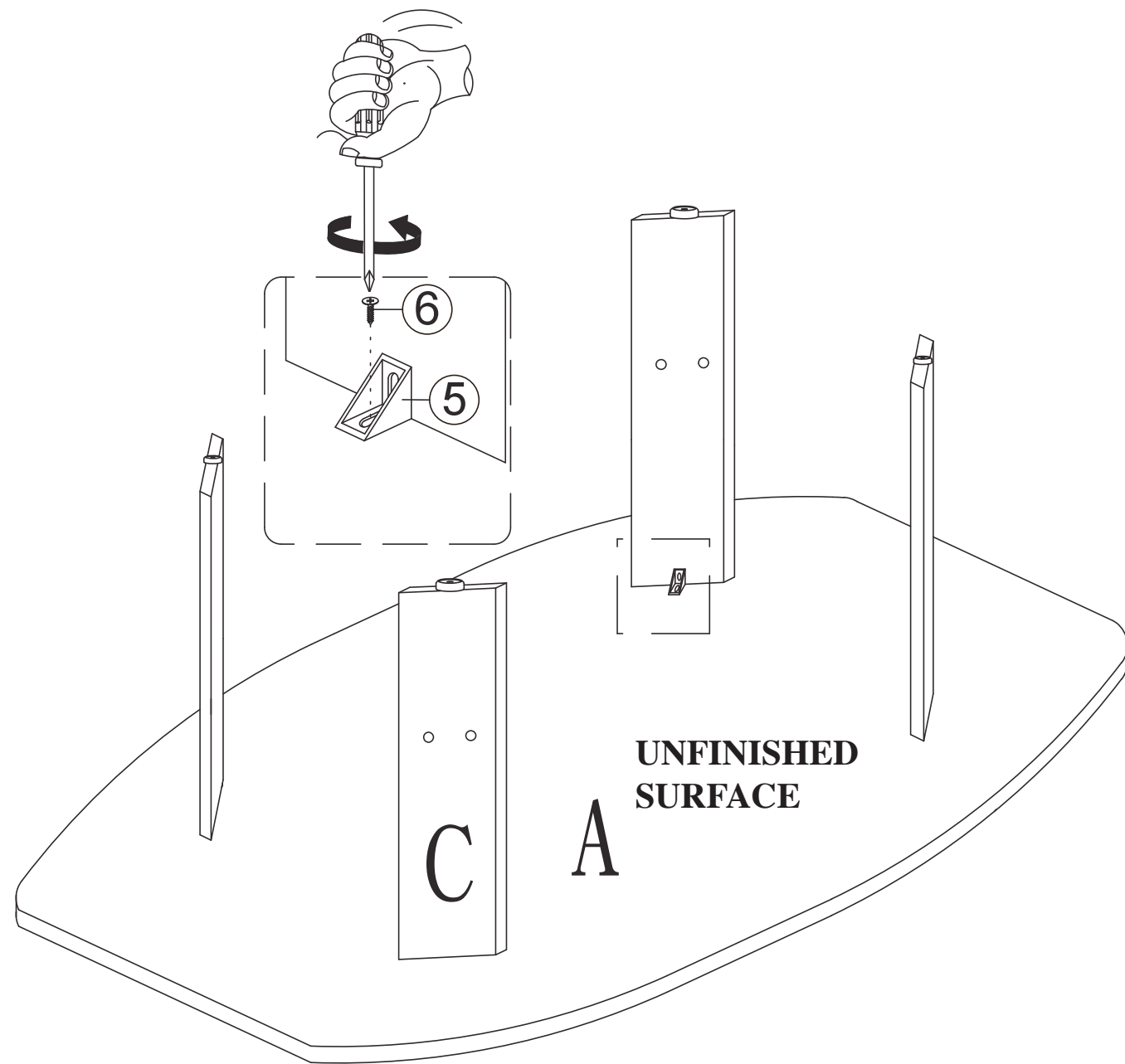

⑤ L-BRACKET - 4 PCS



⑥ TAPPING SCREW - 4 PCS

ANTES DE INICIAR, LEA DETENIDAMENTE LAS INSTRUCCIONES DE ASAMBLEA Y SIGALAS PASO A PASO.

PRECAUCIÓN:

- 1. SE REQUIERE SUPERVISIÓN DE UN ADULTO DEBIDO A LA EXISTENCIA DE PIEZAS PEQUEÑAS. TENGA CUIDADO AL DESAMBLAR EL PRODUCTO.**
- 2. ARME EL PRODUCTO SOBRE SUPERFICIES SUAVES PARA EVITAR DAÑOS AL ACABADO.**
- 3. ASEGURESE DE QUE ESTEN TODAS LAS PIEZAS ANTES DE ASAMBLARLO.**

HERRAMIENTA DE ASAMBLEA NECESARIAS

DESTORNILLADOR DE CRUZ

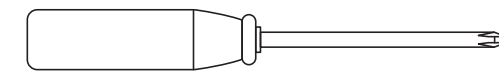

MARTILLO

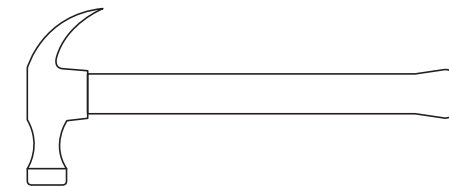

MAZO DE GOMA

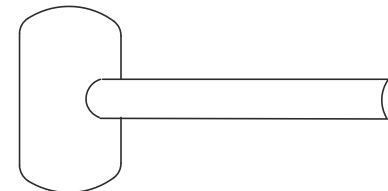

LISTA DE ACCESORIOS Y PARTES

NO	LISTA DE ACCESORIOS	CNT
1	CLAVIJA DE MADERA 	8 PZS
2	TORNILLO C/B 	8 PZS
3	DESLIZADORES 	4 PZS
4	PEGAMENTO 	1 PZ
5	SOPORTE 	4 PZS
6	TORNILLO 	8 PZS

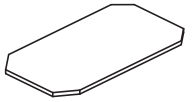
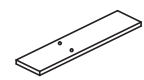
NO	LISTA DE PARTES	CNT
A	PANEL SUPERIOR 	1 PZ
B	ESTANTE 	1 PZ
C	PATA 	4 PZS

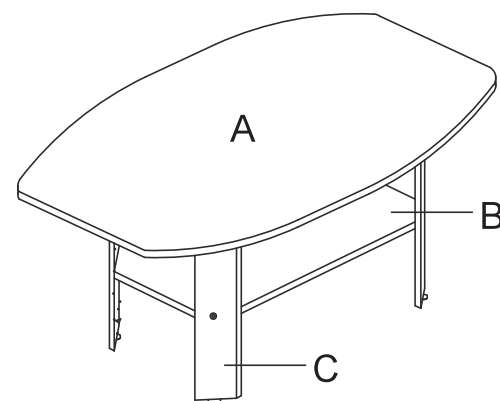

STEP 4

ATTACH THE SHELF PANEL (B) TO THE LEGS (C) USING THE C/B SCREW (2), AS SHOWN.
THEN ALLOW THE GLUE TO DRY COMPLETELY.

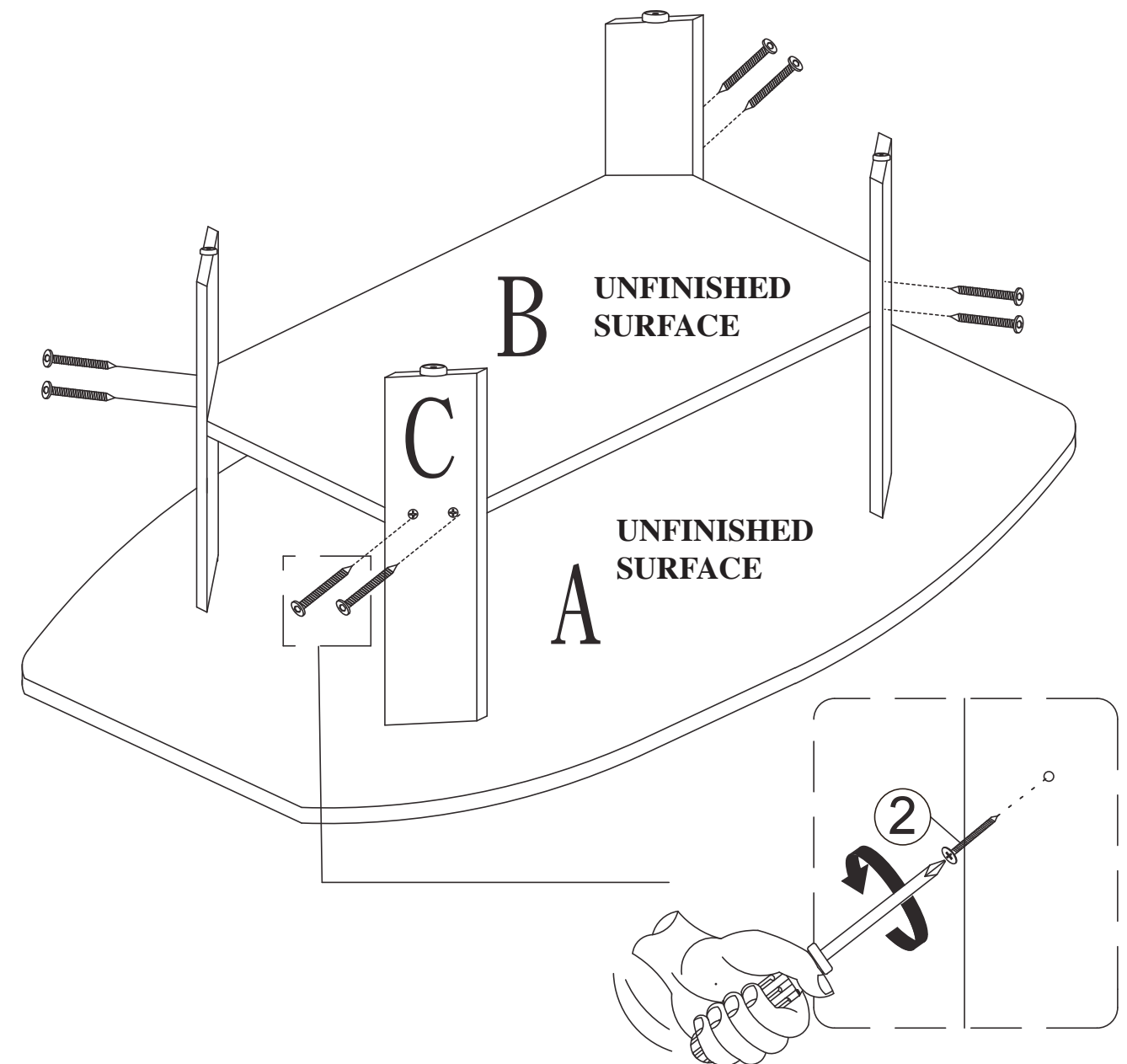

② C/B SCREW M4 x 45mm - 8 PCS

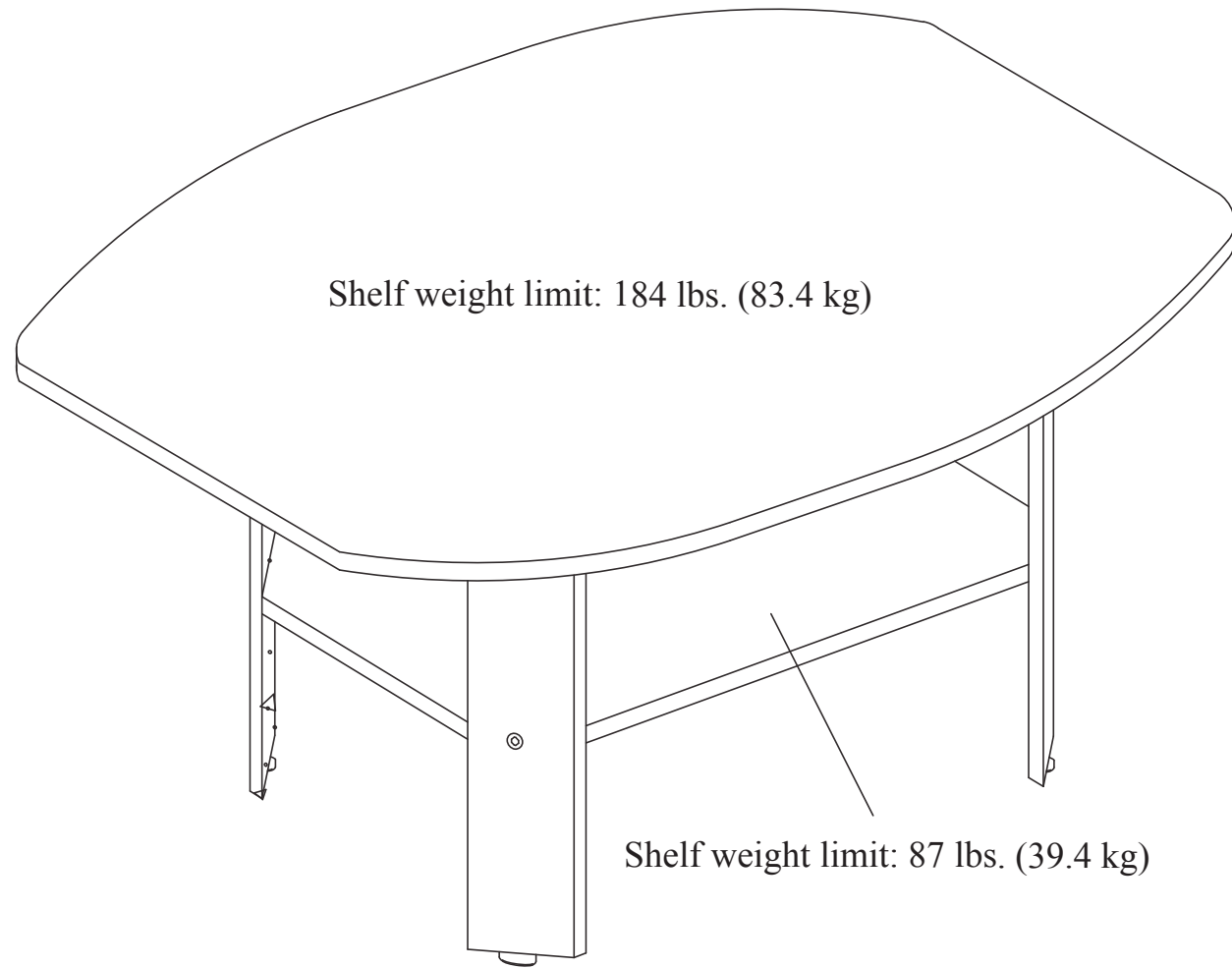

This unit is intended for use only with the products and maximum weights indicated. Use with other products or products heavier than the maximum weights indicated may result in instability causing possible injury. Furniture can tip over or break if improperly moved. Have a friend help to lift and carry the unit to its new location.

Do you have any questions? Missing small parts or hardware?
If you need assistance with the assembly of your COFFEE TABLE please e-mail our Customer Service Department at: support@fourstari.com or call us at (508) 435-4830 or (800) 639-3803

Please include the following information in your email:

- Where item was purchased
- Item, model, style or SKU number listed on instructions or box
- Part number, description of the part and quantity needed

This information will help us get the proper part to you faster



fourstargroup

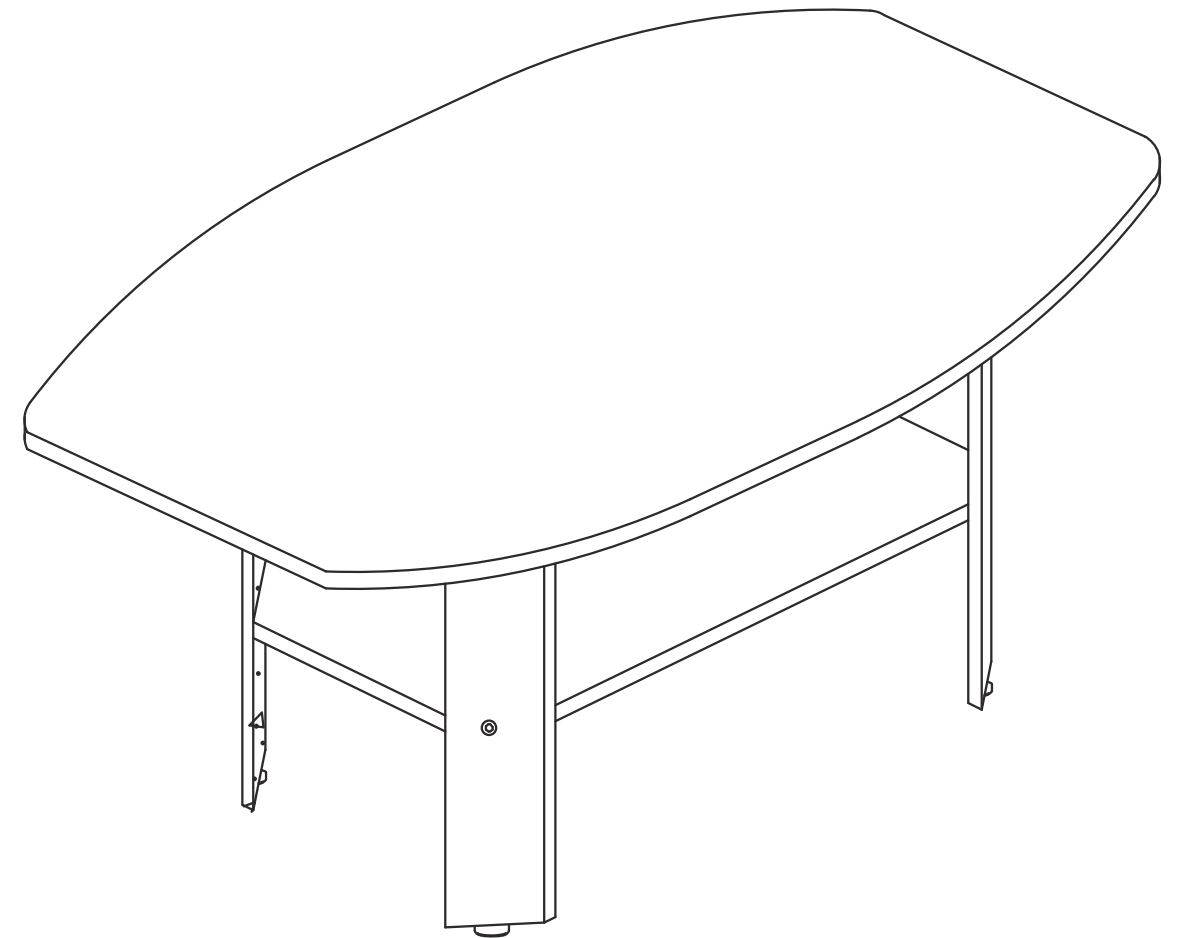

MODELO: 11211717P
MESA DE CAFE