

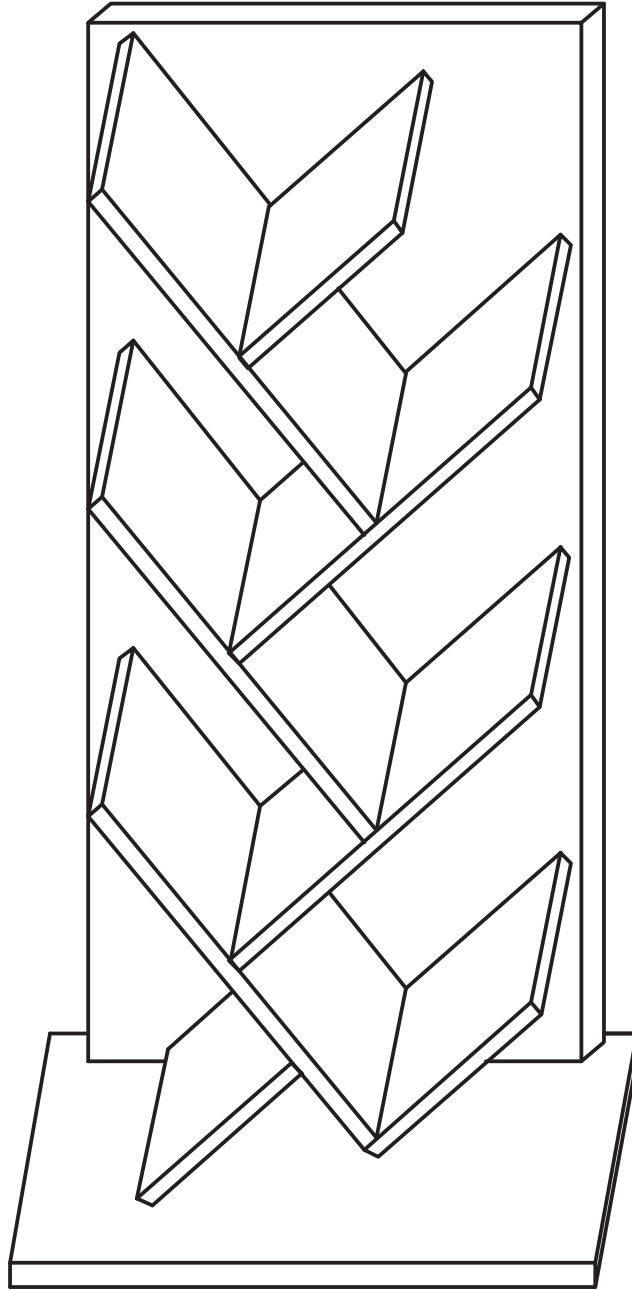







fourstargroup







**MODEL: 11210912**

**MEDIA ORGANIZER**

## PARTS LIST AND HARDWARE

NO	HARDWARE LIST	QTY
1	SCREW M4 x 32 mm 	21 PCS
2	PLASTIC DOWEL M5 x 20 mm 	14 PCS
3	WALL BRAKET 	2 PCS
4	WHITE GLUE 	1 PC
5	SCREW M3 x 9 mm 	4 PCS
6	WALL PLUG 	2 PCS

NO	PARTS LIST	QTY
A	BACK PANEL 	1 PC
B	BOTTOM PANEL 	1 PC
C	SHELF - SMALL (1)(2)(3) 	3 PCS
D	SHELF - LEFT 	3 PCS
E	SHELF - RGIHT 	2 PCS

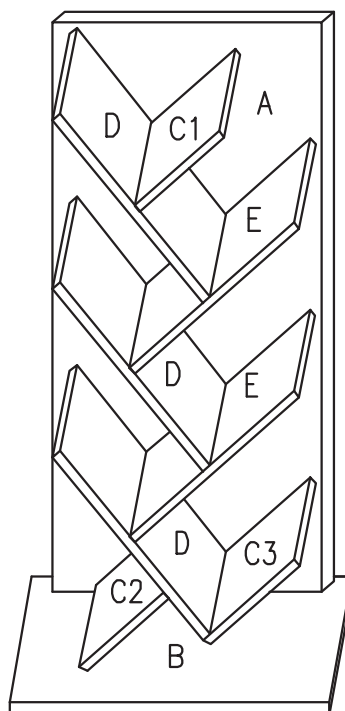

**BEFORE YOU BEGIN , PLEASE READ ASSEMBLY INSTRUCTIONS CAREFULLY. FOLLOW THEM STEP BY STEP.**

**CAUTION:**

- 1. ADULT SUPERVISION IS REQUIRED DUE TO SMALL PARTS. CARE SHOULD BE TAKEN IN THE UNPACKING AND ASSEMBLY OF THE PRODUCT.**
- 2. ASSEMBLE ON SOFT SURFACES TO PREVENT DAMAGE TO THE PRODUCT FINISH.**
- 3. MAKE SURE ALL PARTS ARE INCLUDED BEFORE ASSEMBLY.**

**ASSEMBLY TOOLS REQUIRED**

**PHILIPS  
SCREWDRIVER**

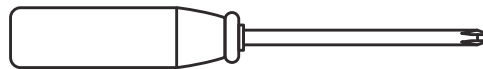

**RUBBER Mallet**

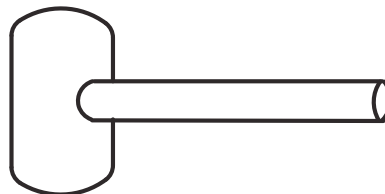

# ASSEMBLY INSTRUCTIONS

## STEP 1

1.1 INSTALL THE PLASTIC DOWEL (2) TO THE SHELF PANELS (C & D) USING THE GLUE (4), AS SHOWN.

1.2 INSTALL THE WALL BRACKET (METAL) (3) TO THE BACK PANEL (A) USING THE SCREWS (5), AS SHOWN.

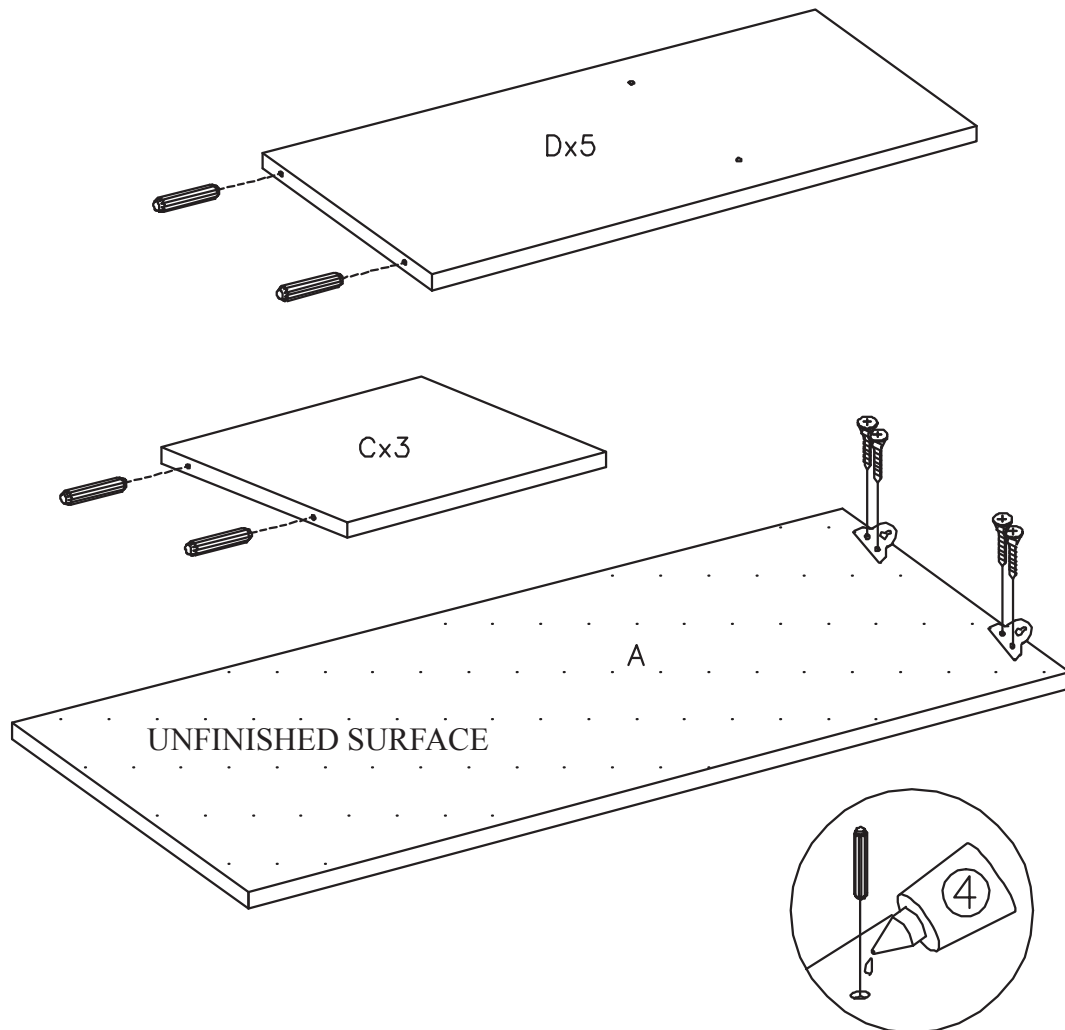

③ WALL BRACKET (METAL) - 2PCS



⑤ SCREW - 4PCS



② PLASTIC DOWEL M5 x 20mm - 14PCS



④ WITH GLUE - 1PC

**STEP 2**

**ATTACH BOTTOM PANEL (B) TO THE BACK PANEL (A) USING THE SCREW (1), AS SHOWN.**

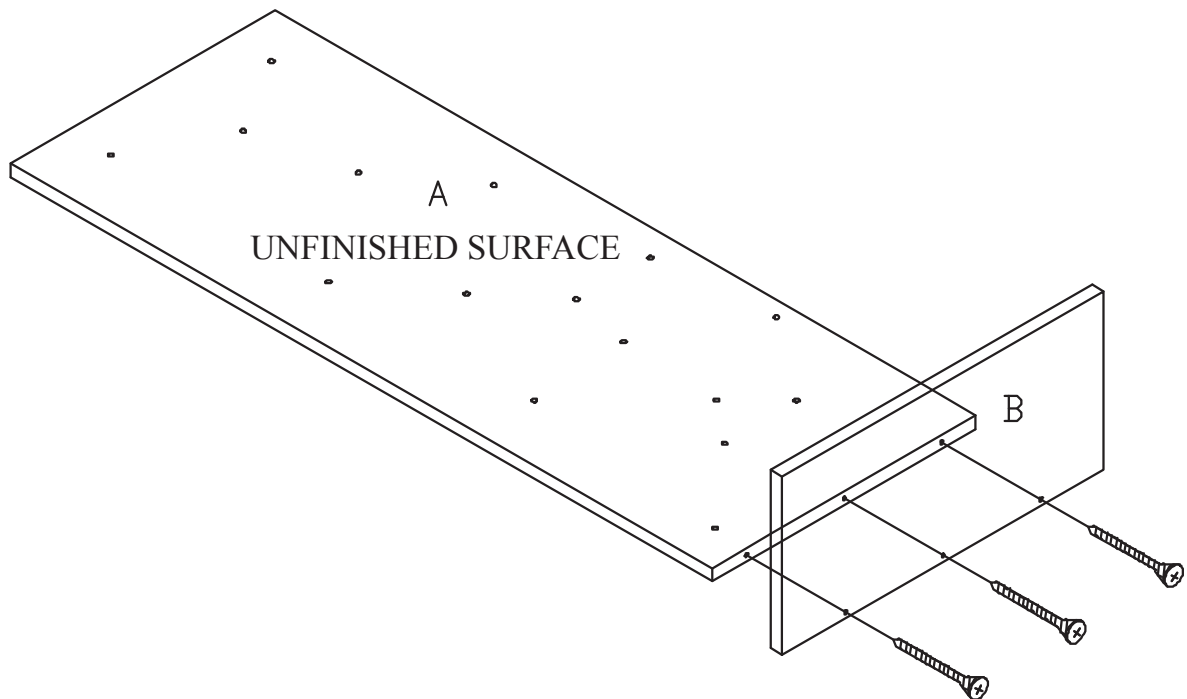

**① SCREW - 3 PCS**

**STEP 3**

**ATTACH THE SMALL SHELF (C), LEFT SHELF (D) AND RIGHT SHELF (E) USING THE GLUE (4), AS SHOWN.**

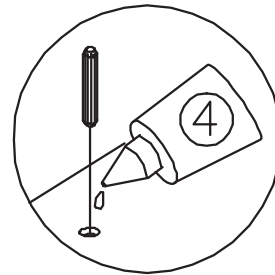
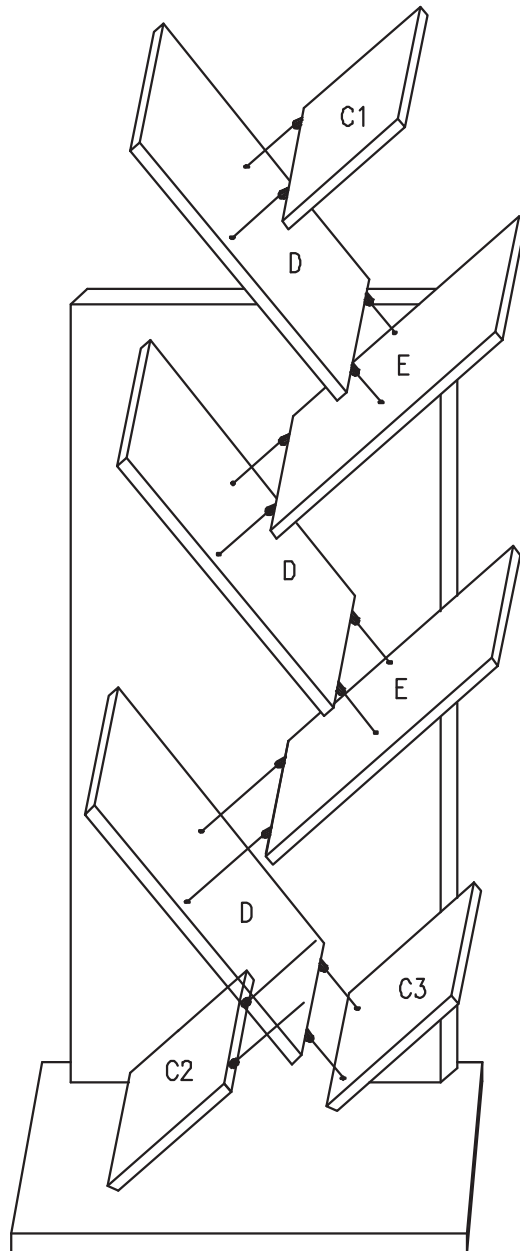

**④ WITH GLUE - 1PC**

**STEP 4**

**ATTACH THE ASSEMBLED PARTS FROM STEP 3 TO THE ASSEMBLED PARTS FROM STEP 2 USING THE SCREWS (1), AS SHOWN.**

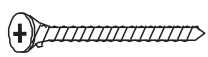
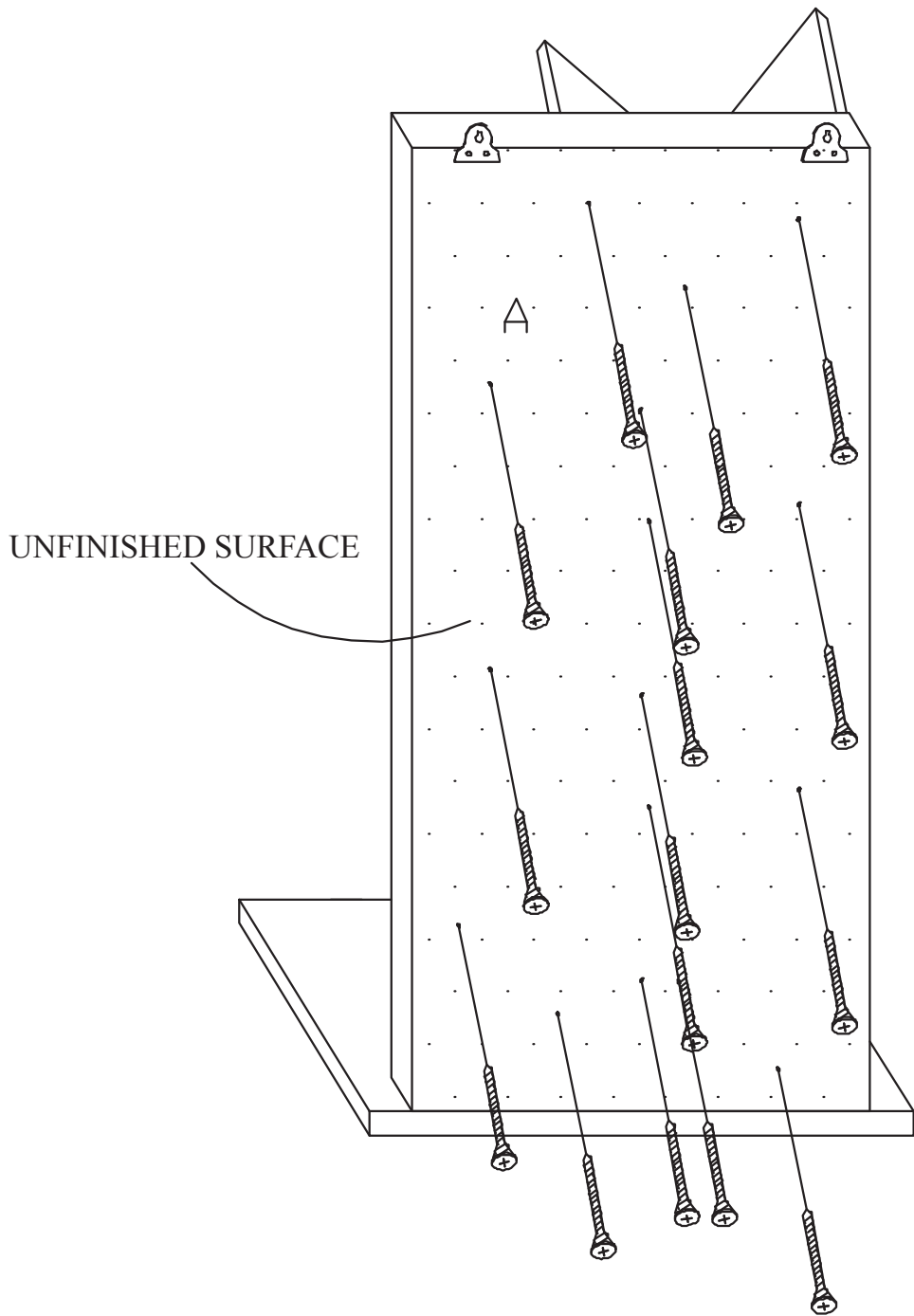

**① SCREW - 16 PCS**

## STEP 5

**5.1 DRILL THE HOLES ON THE WALL AND INSERT THE WALL PLUG (6), INSTALL THE SCREW (1) WITH SCREW DRIVER.**

**5.2 HANG THE ORGANIZER ON THE WALL.**

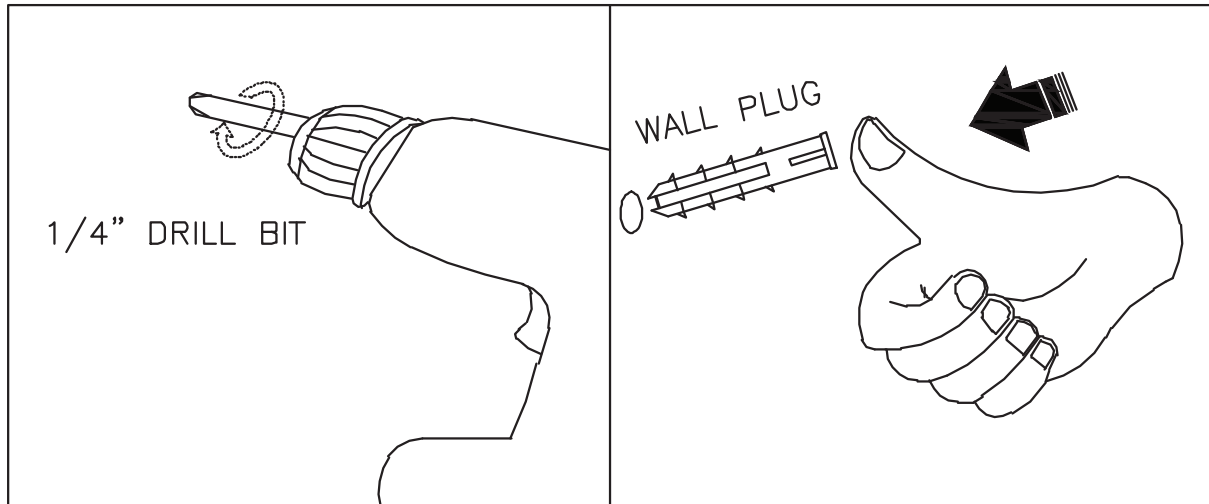

 **⑥ WALL PLUG - 2 PCS**

Shelf weight limit: 11.5 lbs. (5.2 kg)

This unit is intended for use only with the products and maximum weights indicated. Use with other products or products heavier than the maximum weights indicated may result in instability causing possible injury. Furniture can tip over or break if improperly moved. Have a friend help to lift and carry the unit to its new location.

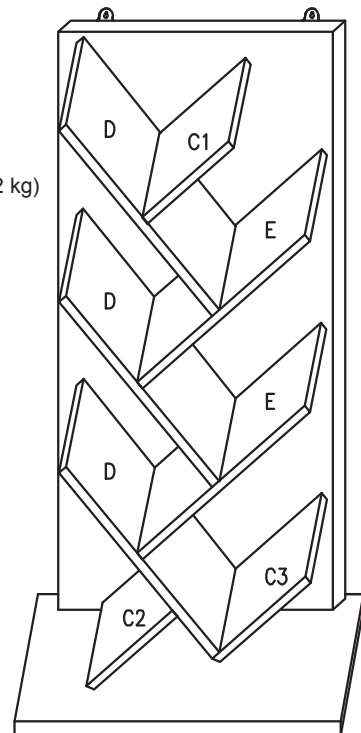

Do you have any questions? Missing small parts or hardware?  
If you need assistance with the assembly of your MEDIA ORGANIZER please e-mail our Customer Service Department at: [support@fourstari.com](mailto:support@fourstari.com) or call us at (508) 435-4830 or (800) 639-3803

Please include the following information in your email:

- Where item was purchased
- Item, model, style or SKU number listed on instructions or box
- Part number, description of the part and quantity needed

This information will help us get the proper part to you faster