

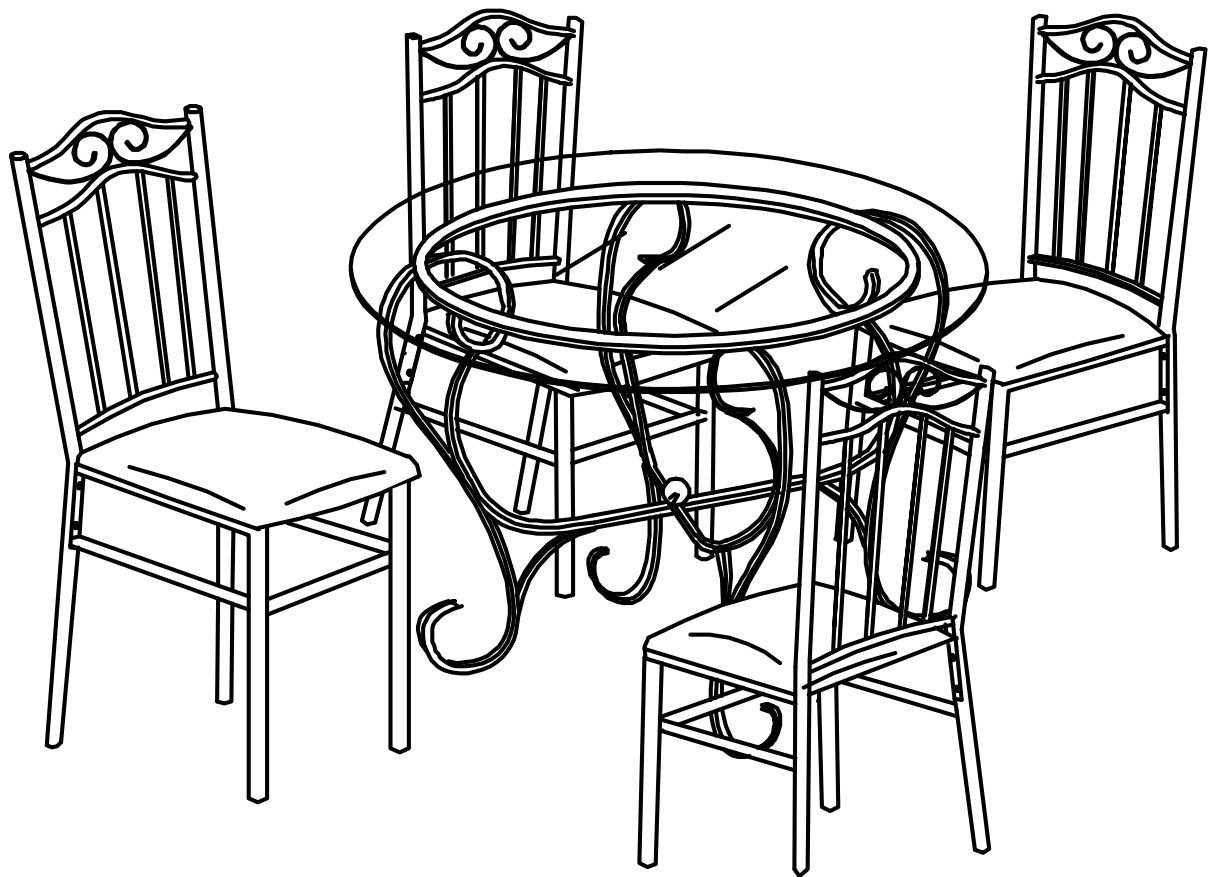

fourstargroup











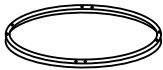

MODEL: 11223193

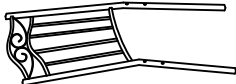
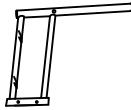
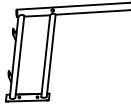
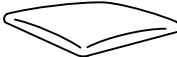
5 PIECE DINING SET
JUEGO DE COMEDOR DE 5 PIEZAS

PARTS LIST AND HARDWARE

LISTA DE PARTES Y ACCESORIOS

A		GLASS TOP CRISTAL SUPERIOR	1PC 1PZ
BT		TOP LEG (BIG HOLE) PATA SUPERIOR (GRAN AGUJERO)	1PC 1PZ
BB		BELOW LEG (SMALL HOLE) PATA INFERIOR (AGUJERO PEQUEÑO)	1PC 1PZ
C		RING ANILLO	1PC 1PZ
D		BALL BOLA	1PC 1PZ
E		CHAIR BACK PARTE TRASERA DE LA SILLA	4PCS 4PZS
F		LEFT CHAIR LEG PATA DE LA SILLA IZQUIERDA	4PCS 4PZS
G		RIGHT CHAIR LEG PATA DE LA SILLA DERECHA	4PCS 4PZS
H		CUSHION ALMOHADON	4PCS 4PZS
I		CONNECTOR CONECTOR	4PCS 4PZS
①		BOLT 1/2 in. TORNILLO 1/2 in.	24PCS 24PZS
②		BOLT 1-5/8 in. TORNILLO 1-5/8 in.	8PCS 8PZS
③		WOOD SCREW TORNILLO DE MADERA	16PCS 16PZS
④		ALLEN WRENCH LLAVE ALLEN	1PC 1PZ
⑤		SUCTION CUP VENTOSAS	4PCS 4PZS

ASSEMBLY INSTRUCTIONS INSTRUCCIONES DE MONTAJE

STEP 1

CROSS CENTER BARS OF BOTH LEG (BT), (BB) USING BALL(D) AS SHOWN IN BELOW ILLUSTRATION.

PASO 1

CRUZE LAS BARRAS DE AMBAS PATAS (BT), (BB) UTILIZANDO LA BOLA (D) COMO SE MUESTRA EN LA ILUSTRACION DE ABAJO.

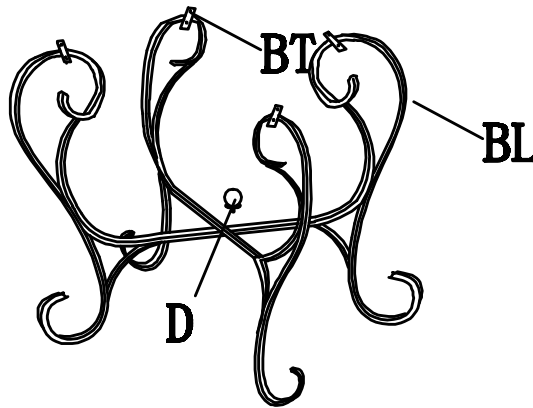

IMPORTANT: DO NOT TIGHTEN BOLTS AS THIS TIME

IMPORTANTE: NO AJUSTE LOS TORNILLOS EN ESTE MOMENTO

STEP 2

ATTACH RING (C) TO LEGS USING BOLT (1) AS SHOWN.

PASO 2

ADJUNTE EL ANILLO (C) A LAS PATAS UTILIZANDO LOS TORNILLOS (1) COMO SE MUESTRA.

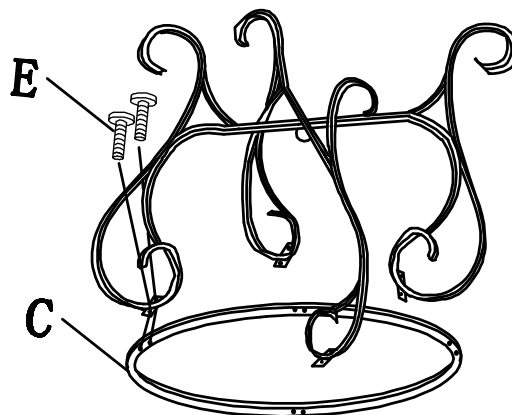

IMPORTANT: DO NOT TIGHTEN BOLTS AS THIS TIME

IMPORTANTE: NO AJUSTE LOS TORNILLOS EN ESTE MOMENTO

STEP 3

PUT SUCTION CUP (5) ONTO RING (C), THEN PLACE GLASS TOP (A) ONTO TABLE FRAME AS SHOWN.

PASO 3

COLOQUE LAS VENTOSAS (5) EN EL ANILLO (C), LUEGO COLOQUE EL CRISTAL SUPERIOR (A) EN LA MESA COMO SE MUESTRA.

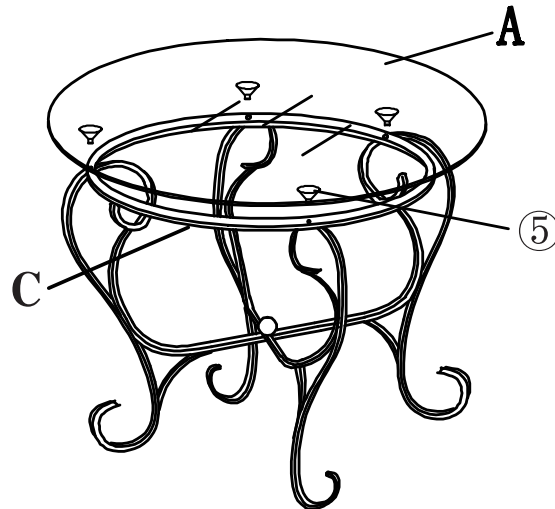

IMPORTANT: TIGHTEN ALL BOLTS

IMPORTANTE: AJUSTE LOS TORNILLOS EN ESTE MOMENTO

STEP 4

ATTACH CHAIR LEG (F) (G) TO EACH CHAIR BACK (E) USING BOTL (1) AS SHOWN.

PASO 4

ADJUNTE LAS PATAS DE LAS SILLAS (F) (G) A LA PARTE TRASERA DE LA SILLA (E) UTILIZANDO LOS TORNILLOS (1) COMO SE MUESTRA.

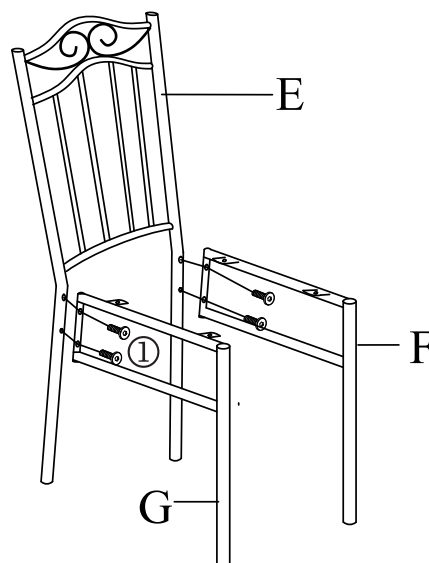

IMPORTANT: DO NOT TIGHTEN BOLTS AS THIS TIME

IMPORTANTE: NO AJUSTE LOS TORNILLOS EN ESTE MOMENTO

STEP 5

ATTACH CONNECTOR (I) TO EACH LEG USING BOLT (2) AS SHOWN.

PASO 5

ADJUNTE EL CONECTOR (I) A CADA PATA UTILIZANDO EL TORNILLO (2) COMO SE MUESTRA.

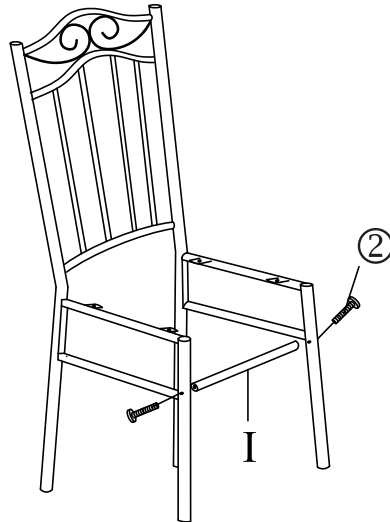

***IMPORTANT:**

**DO NOT TIGHTEN BOLTS
AS THIS TIME***

***IMPORTANTE:**

**NO AJUSTE LOS TORNILLOS
EN ESTE MOMENTO***

STEP 6

ATTACH CUSHION (H) ONTO CHAIR FRAME USING WOOD SCREW (3) AS SHOWN.

PASO 6

ADJUNTE EL ALMOHADON AL MARCO DE LA SILLA CON TORNILLOS DE MADERA (3) COMO SE MUESTRA.

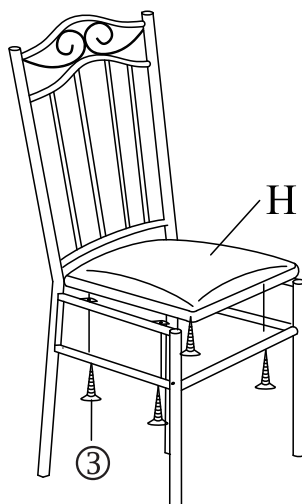

***IMPORTANT:**

TIGHTEN ALL BOLTS*

***IMPORTANTE:**

**AJUSTE LOS TORNILLOS
EN ESTE MOMENTO***

Do you have any questions? Missing small parts or hardware?
If you need assistance with the assembly of your 5 PIECE DINING SET
please e-mail our Customer Service Department at: support@fourstari.com
or call us at (508) 435-4830 or (800) 639-3803

Please include the following information in your email:

- Where item was purchased
- Item, model, style or SKU number listed on instructions or box
- Part number, description of the part and quantity needed

This information will help us get the proper part to you faster

¿Tiene alguna pregunta? ¿Faltan piezas o accesorios pequeños?

Si necesita ayuda para ensamblar su JUEGO DE COMEDOR DE 5 PIEZAS
envíenos un correo electrónico a nuestro Departamento de atención al cliente:
support@fourstari.com o llámenos al (508) 435-4830 o al (800) 639-3803

Incluya la siguiente información en el correo electrónico:

- Dónde compró el producto
- El número de SKU, estilo, modelo o producto que aparece en las instrucciones o la caja
- El número y descripción de la pieza y la cantidad que necesita

Esta información nos ayudará a enviarle la pieza correcta con mayor rapidez