















fourstargroup

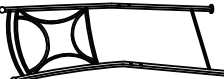

MODEL: 11222151VW / MODELO: 11222151VW

3 PIECE BAR SET
JUEGO DE BAR DE 3 PIEZAS

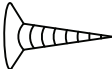
PARTS LIST AND HARDWARE LISTA DE PARTES Y ACCESORIOS

NO	HARDWARE LIST LISTA DE ACCESORIOS	QTY CNT
A	TABLE RING ANILLO DE MESA 	1 PC 1 PZ
B	TABLE LEG PATA DE LA MESA 	4 PCS 4 PZS
C	TABLE LINK CONNECTOR DE LA MESA 	1 PC 1 PZ
D	GLASS TOP MESA SUPERIOR 	1 PC 1 PZ
E	SUCTION CUP VENTOSA 	4 PCS 4 PZS
F	CHAIR BACK RESPALDO DE LA SILLA 	2 PCS 2 PZS
G	LEFT CHAIR LEG PATA DE LA SILLA IZQUIERDA 	2 PCS 2 PZS
H	RIGHT CHAIR LEG PATA DE LA SILLA DERECHA 	2 PCS 2 PZS
I	BOTTOM LINK CONECTOR INFERIOR 	2 PCS 2 PZS
J	SEAT SUPPORT LINK SOPORTE CONECTOR DE LA SILLA 	2 PCS 2 PZS
K	CHAIR CUSHION COJIN DE LA SILLA 	2 PCS 2 PZS
L	BOLT 30MM TORNILLO 30MM 	16 PCS 16 PZS
M	WOOD SCREW 15MM TORNILLO DE MADERA 15MM 	8 PCS 8 PZS
N	ALLEN WRENCH LLAVE ALLEN 	1 PC 1 PZ
O	BOLT 12MM TORNILLO 12MM 	28 PCS 28 PZS

ASSEMBLY INSTRUCTIONS

INSTRUCCIONES DE MONTAJE

CAUTION:

1. READ THIS INSTRUCTION MANUAL BEFORE YOU ASSEMBLE.
2. ASSEMBLE ON SOFT SURFACES TO PREVENT DAMAGE TO THE PRODUCT FINISH.
3. RECOMMEND TWO PEOPLE TO ASSEMBLE THE PRODUCT.

PRECAUCION:

1. LEA ESTE MANUAL DE INSTRUCCIONES ANTES DE ARMAR.
2. MONTAR SOBRE SUPERFICIES BLANDAS PARA EVITAR DAÑOS AL EL ACABADO DEL PRODUCTO
3. SE RECOMINEDA ARMAR ESTE PRODUCTO ENTRE DOS PERSONAS.

ASSEMBLY TOOL REQUIRED

PHILIPS SCREWDRIVER

HERRAMIENTAS REQUESRIDAS

DESTORNILLADOR PHILIPS

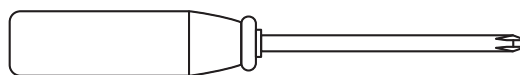

STEP 1

ATTACH TABLE LEGS (B) TO TABLE RING (A) USING BOLTS (O) AS SHOWN.

PASO 1

ADJUNTE LAS PATAS DE LA MESA (B) A LOS ANILLOS DE MESA (A) UTILIZANDO LOS TORNILLOS (O) COMO SE MUESTRA.

DON'T TIGHTEN ALL BOLTS

NO AJUSTE TOTALMENTE LOS TORNILLOS

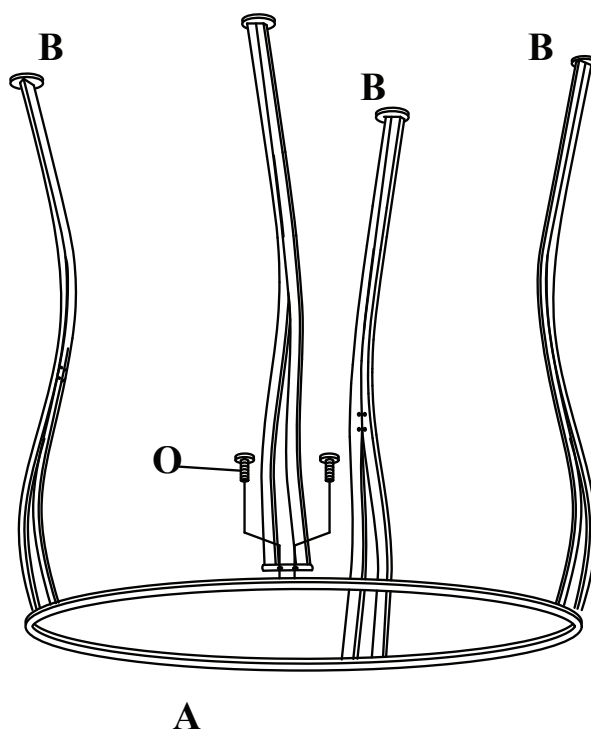

STEP 2

ATTACH TABLE LINK (C) TO EACH LEG USING BOLTS (O) AS SHOWN.

PASO 2

FIJE EL CONECTOR DE LA MESA (C) A CADA PIERNA CON LOS PERNOS (O) COMO SE MUESTRA.

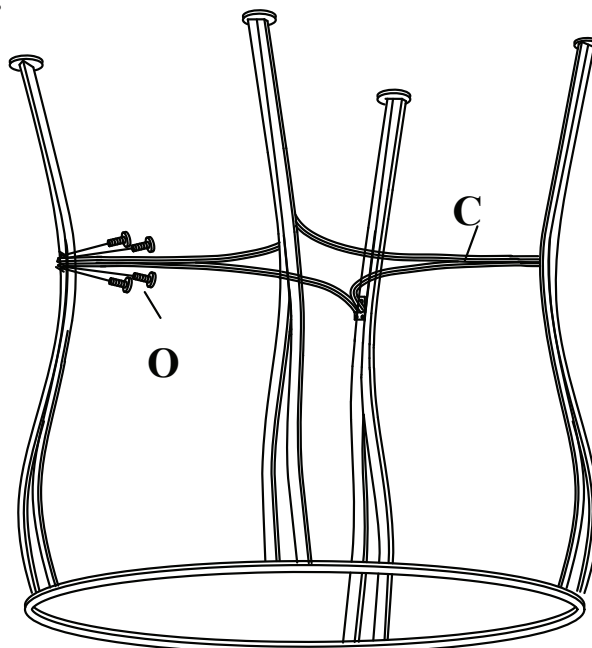

STEP 3

PUT SUCTION CUPS (E) ON THE HOLES OF TABLE RING, THEN PLACE GLASS TOP (D) ON THE TABLE RING AS SHOWN.

PASO 3

COLOCAR LAS VENTOSAS (S) EN LOS AGUJEROS DEL ANILLO DE LA MESA Y LUEGO COLOQUE LA MESA DE VIDRIO (D) EN EL ANILLO DE LA MESA COMO SE MUESTRA.

TIGHTEN ALL BOLTS

APRIETE TODOS LOS TORNILLOS.

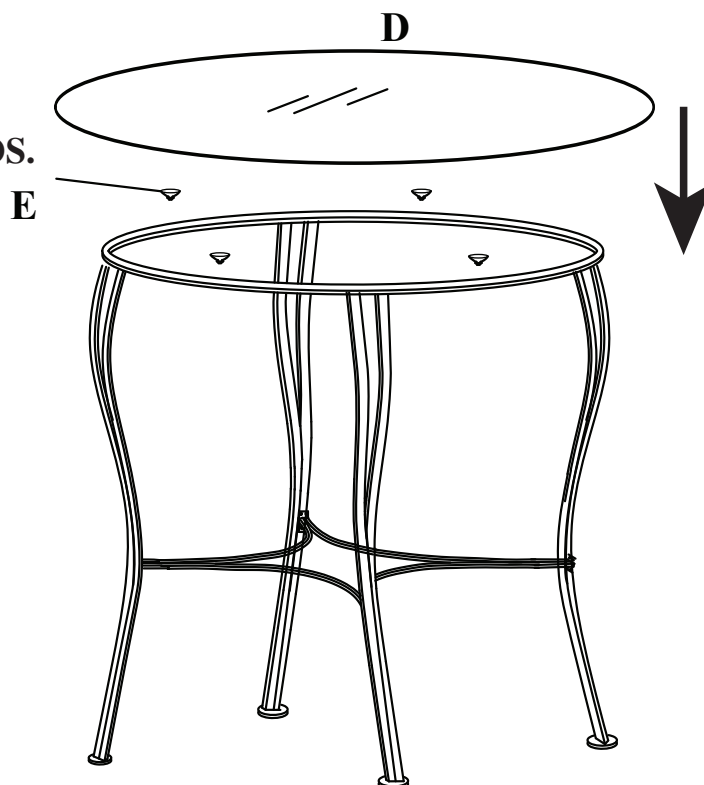

STEP 4

ATTACH LEFT CHAIR LEG (G) AND RIGHT CHAIR LEG (H) TO CHAIR BACK (F) USING BOLTS (L) AS SHOWN.

PASO 4

ADJUNTE LA PATA IZQUIERDA (G) Y LA PATA DERECHA (H) AL RESPALDO DE LA SILLA (F) UTILIZANDO TORNILLOS (L) COMO SE MUESTRA.

DON'T TIGHTEN ALL BOLTS

NO AJUSTE TOTALMENTE LOS TORNILLOS

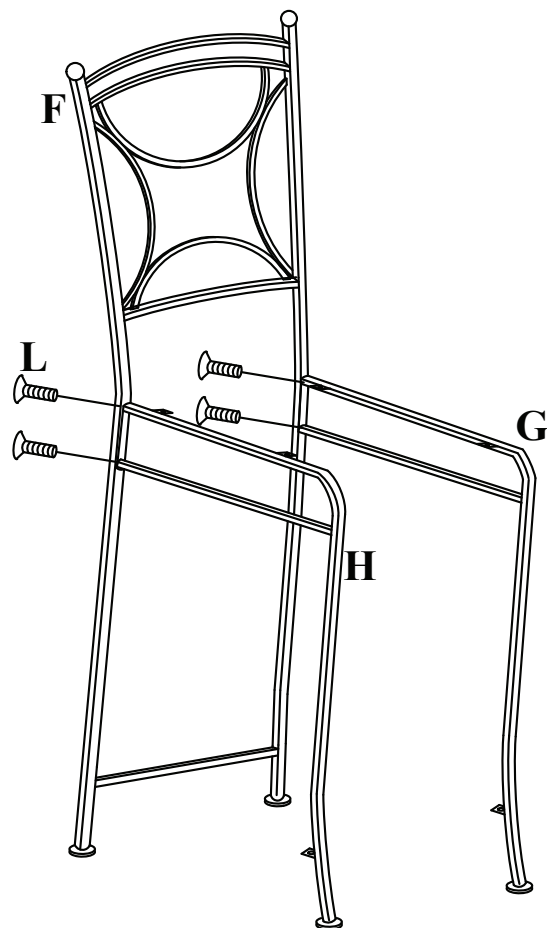

STEP 5

5.1 ATTACH BOTTOM LINK (I) TO LEG FRAME USING BOLTS (L) AND BOLT (O) AS SHOWN.

5.2 ATTACH SEAT SUPPORT LINK (J) TO LEG FRAME USING BOLTS (L) AS SHOWN.

PASO 5

5.1 FIJE EL CONECTOR INFERIOR (I) AL MARCO UTILIZANDO TORNILLOS (L) Y EL PERNO (O), COMO SE MUESTRA.

5.2 ADJUNTE EL SOPORTE CONECTOR DE LA SILLA (J) AL MARCO UTILIZANDO TORNILLOS (L) COMO SE MUESTRA

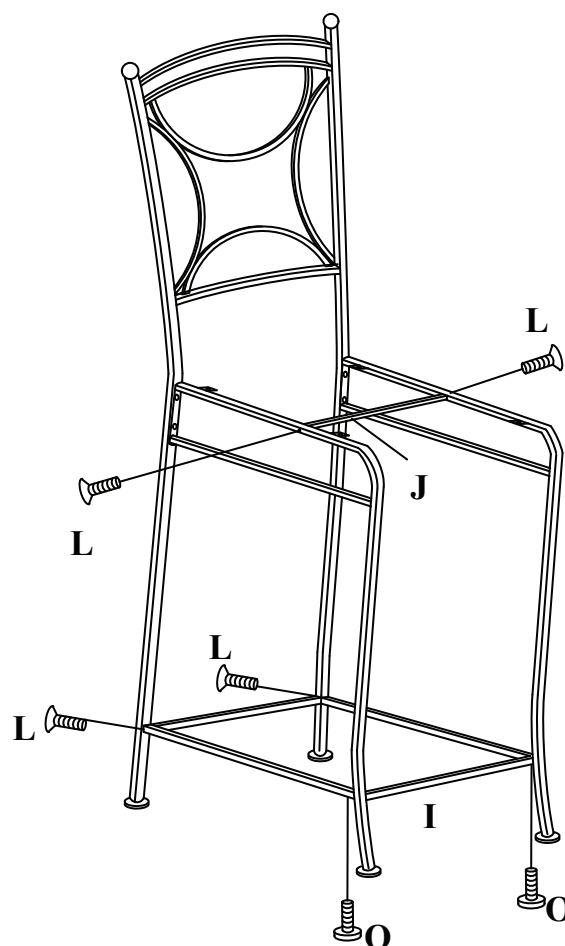

STEP 6

ATTACH CHAIR CUSHION (K) TO LEG FRAME USING WOOD SCREW (M) AS SHOWN.

PASO 6

ADJUNTE EL COJIN DE LA SILLA (K) AL MARCO UTILIZANDO TORNILLOS DE MADERA (M) COMO SE MUESTRA .

TIGHTEN ALL BOLTS

AJUSTE TOTALMENTE LOS TORNILLOS

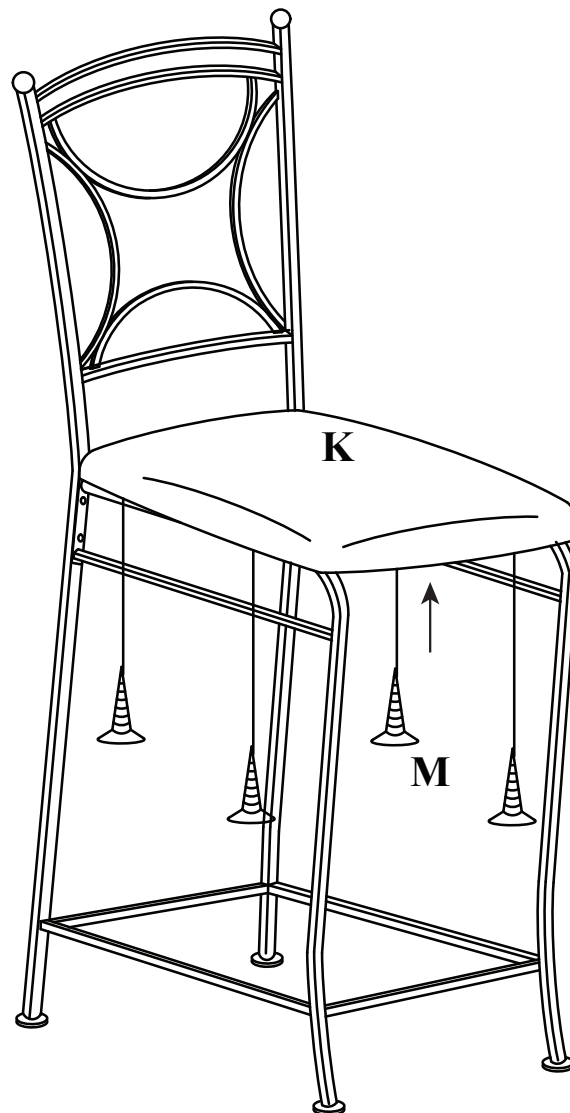

Do you have any questions? Missing small parts or hardware?
If you need assistance with the assembly of your 3 PIECE BAR SET
please e-mail our Customer Service Department at: support@fourstari.com
or call us at (508) 435-4830 or (800) 639-3803

Please include the following information in your email:

- Where item was purchased
- Item, model, style or SKU number listed on instructions or box
- Part number, description of the part and quantity needed

This information will help us get the proper part to you faster

¿Tiene alguna pregunta? ¿Faltan piezas o accesorios pequeños?

Si necesita ayuda para ensamblar su JUEGO DE BAR DE 3 PIEZAS
envíenos un correo electrónico a nuestro Departamento de atención al cliente:
support@fourstari.com o llámenos al (508) 435-4830 o al (800) 639-3803

Incluya la siguiente información en el correo electrónico:

- Dónde compró el producto
- El número de SKU, estilo, modelo o producto que aparece en las instrucciones o la caja
- El número y descripción de la pieza y la cantidad que necesita

Esta información nos ayudará a enviarle la pieza correcta con mayor rapidez