

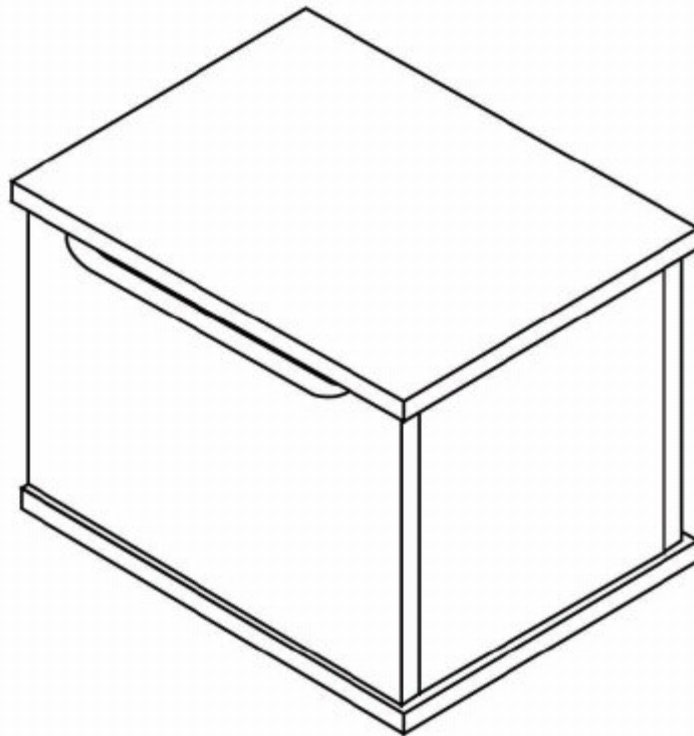











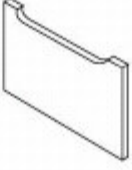

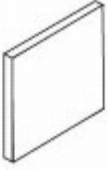
fourstargroup

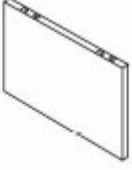

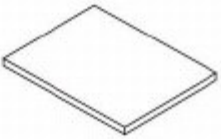
MODEL: 11221099A

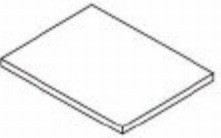
**WOOD STORAGE TRUNK**

## PARTS LIST AND HARDWARE

<p>(1) FRONT PANEL 1PC</p> 	<p>A. LONG SCREW 10PCS</p> 
<p>(2) SIDE PANEL 2PCS</p> 	<p>B. WOOD DOWEL 12PCS</p> 
<p>(3) BACK PANEL 1PC</p> 	<p>C. CAM LOCK 8PCS</p> 
<p>(4) BOTTOM PANEL 1PC</p> 	<p>D. FEET 4PCS</p> 
<p>(5) TOP PANEL 1PC</p> 	<p>E. SUPPORT BAR 1PC</p> 
	<p>F. HINGE 2PCS</p> 
	<p>G. SHORT SCREW 12PCS</p> 

# ASSEMBLY INSTRUCTIONS

## STEP 1

Attach side panel (2) to the back panel (3) using wood dowel (B) and cam lock (C), then attach front panel (1) to side panel (2) using wood dowel (B) and cam lock (C) as shown.

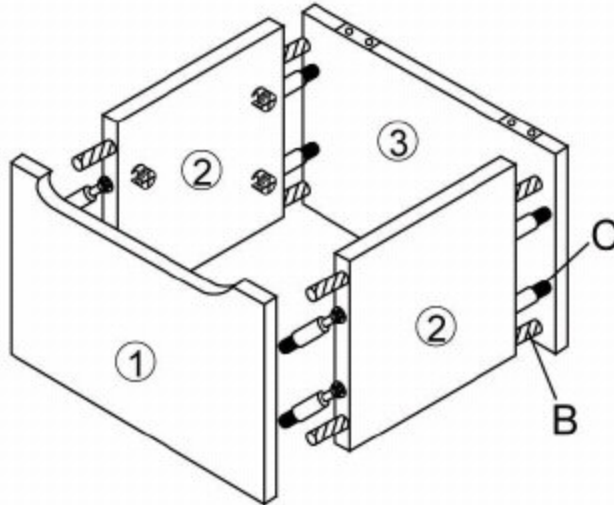

## STEP: 2

Turn it upside down and attach bottom panel (4) to front panel (1), side panel (2) and back panel (3) using long screw (A) and wood dowel (B), then attach feet (D) to bottom panel (4) as shown.

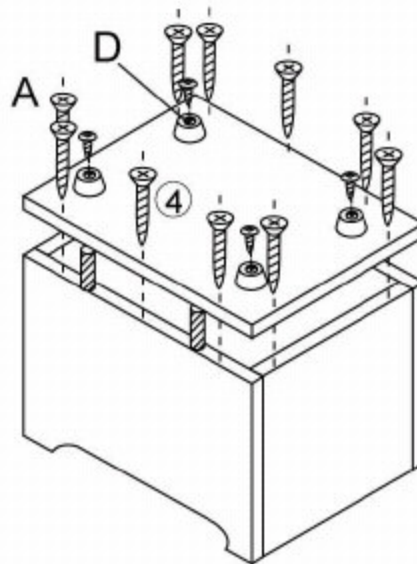

### STEP 3

Connect the top panel (5) and back panel (3) together using hinge (F) and short screw (G), then attach support bar (E) to top panel (5) and side panel (2) using short screw (G) as shown.

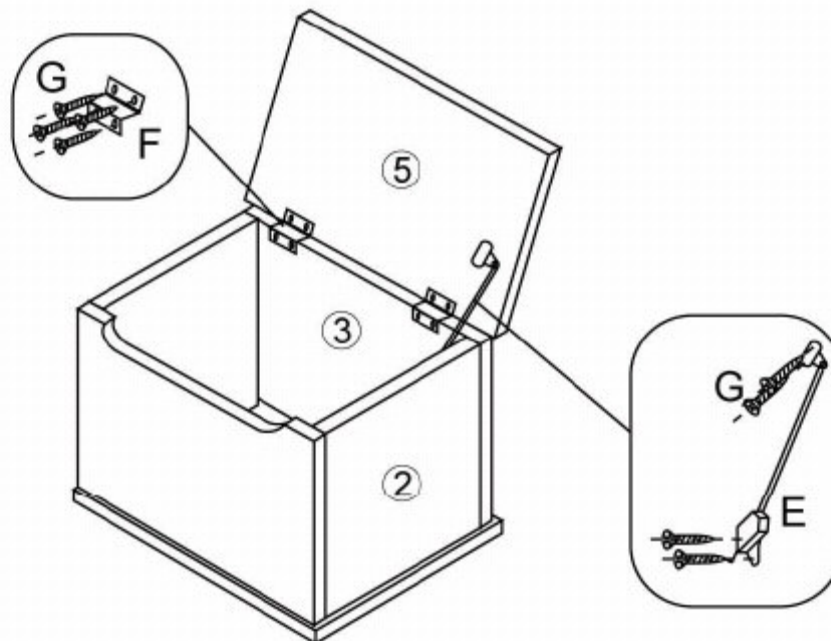

Do you have any questions? Missing small parts or hardware?

If you need assistance with the assembly of your WOOD STORAGE TRUNK please e-mail our Customer Service Department at: [support@fourstari.com](mailto:support@fourstari.com) or call us at (508) 435-4830 or (800) 639-3803

Please include the following information in your email:

- Where item was purchased
- Item, model, style or SKU number listed on instructions or box
- Part number, description of the part and quantity needed

This information will help us get the proper part to you faster