













fourstargroup



MODEL: 11220857FW

7 BINS STORAGE ORGANIZER

PARTS LIST AND HARDWARE

A		TOP PANEL	1PC
B		TOP SHELF	1PC
C		TOP SHELF	1PC
D		SHELF	3PCS
E		DIVIDED PANEL	1PC
F		TOP SPINDLE (SHORT SCREW)	4PC
G		MIDDLE SPINDLE (LONG SCREW)	16PCS
H		FOOT SPINDLE	4PCS
I		SMALL BIN	4PCS
J		LARGE BIN	3PCS

ASSEMBLY INSTRUCTIONS

STEP 1

Place top panel(A) on smooth surface, screw up top spindle(F) on top panel(A) as shown.

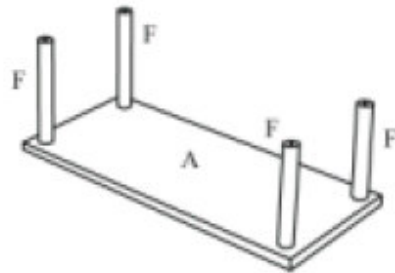

STEP 2

2.1 Attach top shelf(B) using middle spindle(G) as shown.

2.2 Attach divided panel(E) to top shelf(B) as shown.

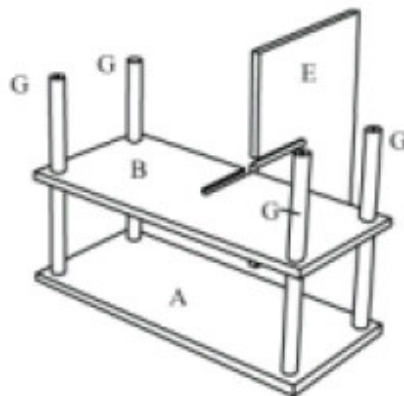

STEP 3

- 3.1 Attach top shelf(C) and shelves(D) using middle spindles(G) as shown.
3.2 Screw foot spindle(H) on shelf (D) as shown.

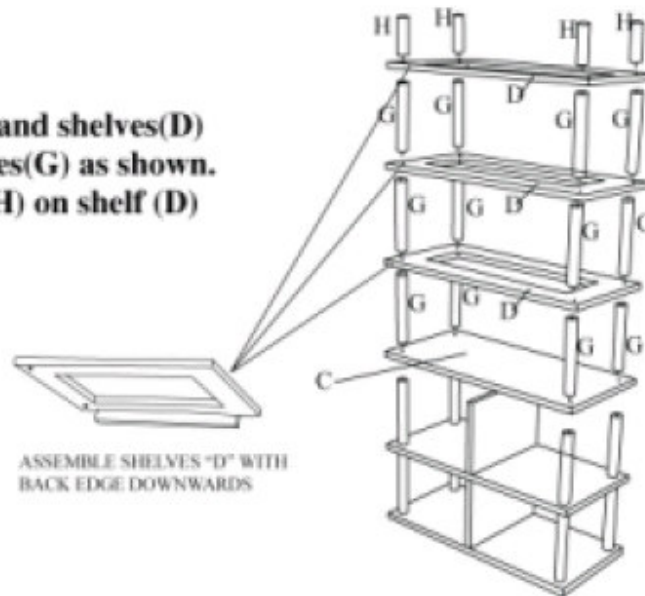

STEP 4

- Put bins (I) (J) on each shelf.

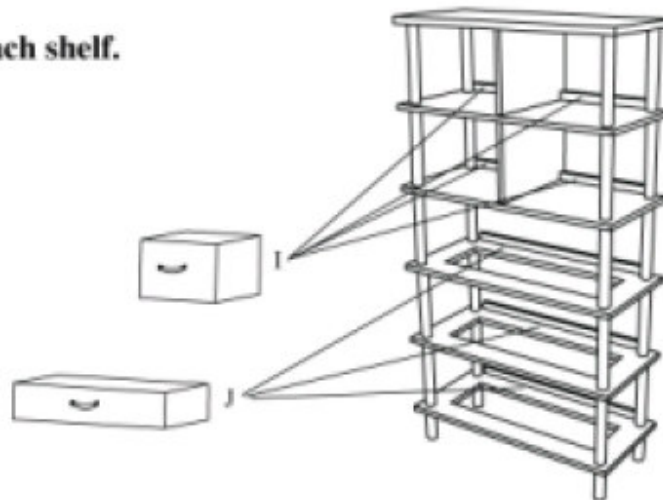

Do you have any questions? Missing small parts or hardware?
If you need assistance with the assembly of your
7 BINS STORAGE ORGANIZER please e-mail our
Customer Service Department at:
support@fourstari.com
or call us at (508) 435-4830
or (800) 639-3893

Please include the following information in your email:
• Where item was purchased
• Item, model, style or SKU number listed on instructions
or box
• Part number, description of the part and quantity needed

This information will help us get the proper part to you faster