

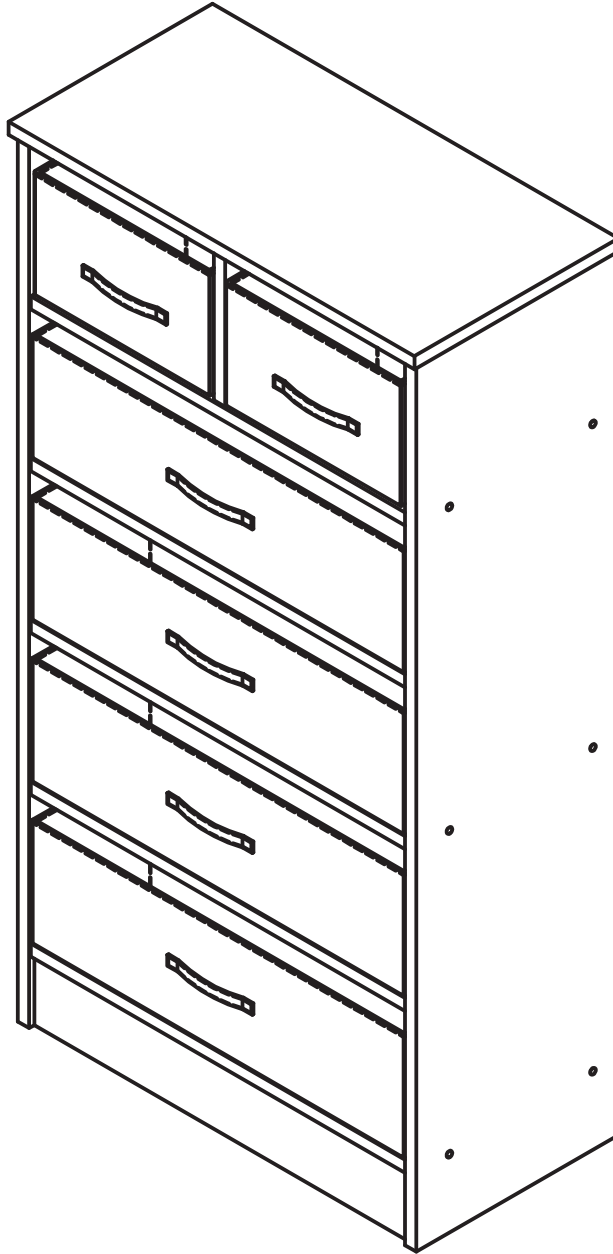

fourstargroup







MODEL: 11213618







6 DRAWER ORGANIZER

PARTS LIST AND HARDWARE

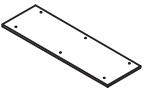
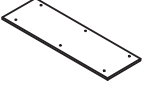
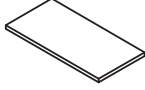
HARDWARE LIST

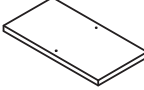
1	DOWEL - M6x30mm	(16 PCS)	
2	SCREW	(12 PCS)	
3	GLUE	(1 PC)	
4	DOWEL - M5x20mm	(4 PCS)	

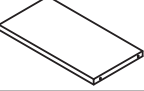
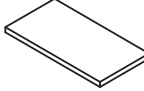
PART LIST

A	SIDE PANEL - L - 1 PC	
B	SIDE PANEL - R - 1 PC	
C	TOP PANEL - 1 PC	
D	CENTER PANEL - 1 PC	
E	FIX PANEL - 1 PC	
F	BOTTOM BAR - 1 PC	
G	FIX PANEL - 2 PCS	
H	FIX PANEL - 2 PCS	
I	STORAGE BIN BIG - 4 PCS	
J	STORAGE BIN SMALL - 2 PCS	

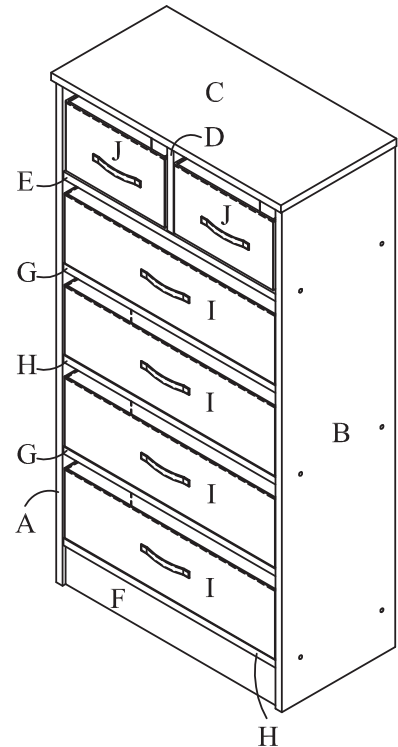

BEFORE YOU BEGIN , PLEASE FOLLOW ASSEMBLY INSTRUCTIONS CAREFULLY. FOLLOW THEM STEP BY STEP.

CAUTION:

- 1. ADULT SUPERVISION IS REQUIRED DUE TO SMALL PARTS. CARE SHOULD BE TAKEN IN THE UNPACKING AND ASSEMBLY OF THE PRODUCT.**
- 2. ASSEMBLE ON SOFT SURFACES TO PREVENT DAMAGE TO THE PRODUCT FINISH.**
- 3. MAKE SURE ALL PARTS ARE INCLUDED BEFORE ASSEMBLY.**

ASSEMBLY TOOLS REQUIRED

RUBBER MALLET

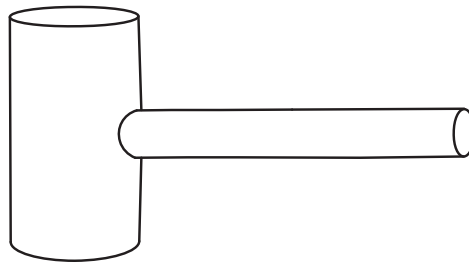

**PHILIPS
SCREWDRIVER**

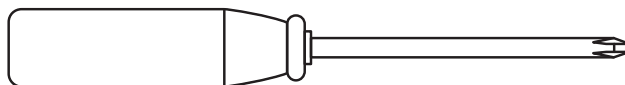

ASSEMBLY INSTRUCTIONS

STEP 1

1.1 INSTALL DOWEL (1) TO CENTER PANEL (D), FIX PANEL (G) AND SIDE PANEL (A & B) WITH GLUE (3).

1.2 INSTALL DOWEL (4) TO BOTTOM BAR (F) WITH GLUE (3).

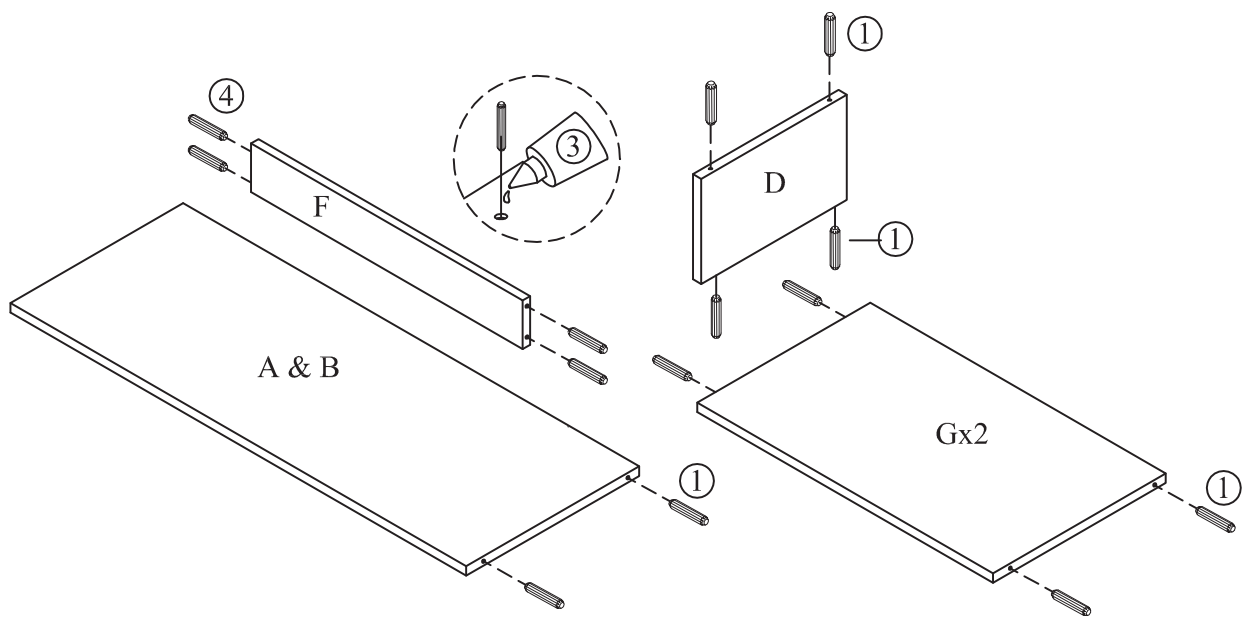

DOWEL - M6x30mm 14PCS



GLUE

STEP 2

-ATTACH FIX PANEL (G) & (H) AND BOTTOM BAR (F) TO SIDE PANEL (A) & (B) USING SCREW (2) AND DOWEL (1 & 4) WITH GLUE (3).

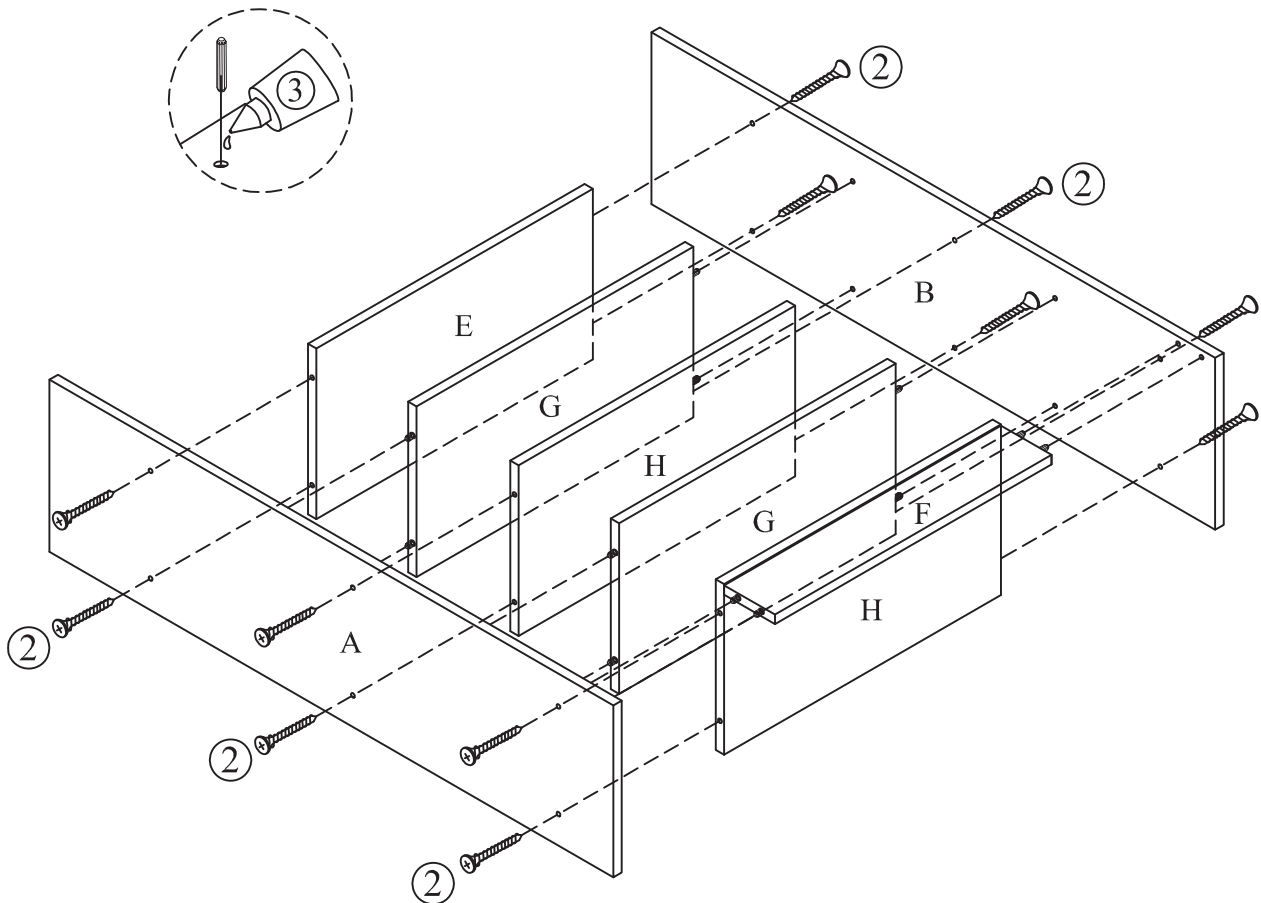

 **DOWEL - M6x30mm 2PCS**

 **SCREW 6PCS**



 **GLUE**

 **DOWEL - M5x20mm 4PCS**

STEP 3

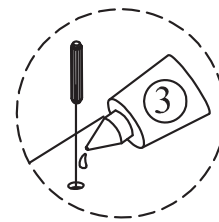
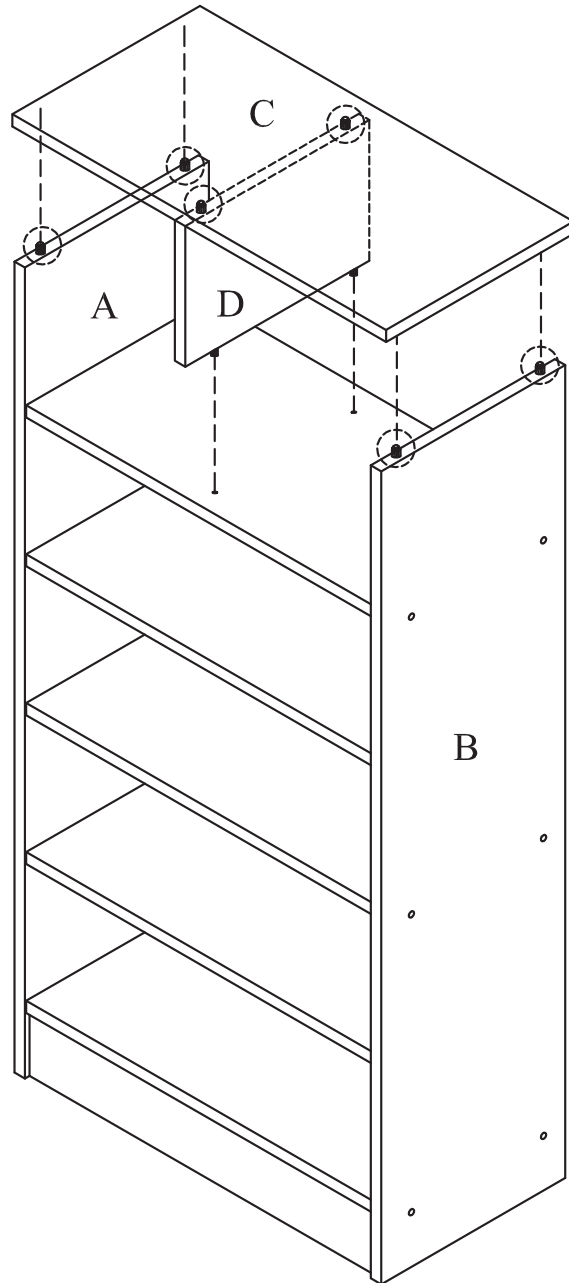
-ATTACH CENTER PANEL (D) ON FIX PANEL (E) TO SIDE PANEL (A & B) AND TOP PANEL (C) USING SCREW (2) AND DOWEL (1) WITH GLUE (3).



-  **DOWEL - M6x30mm 2PCS**
-  **SCREW 6PCS**
-  **GLUE**

STEP 4

-UNFOLD THE DRAWER (I) & (J) AND PUT IN THE CARDBOARD, AS SHOWN.

-SLIDE THE DRAWER (I) & (J) TO THE ASSEMBLED CABINET AS SHOWN.

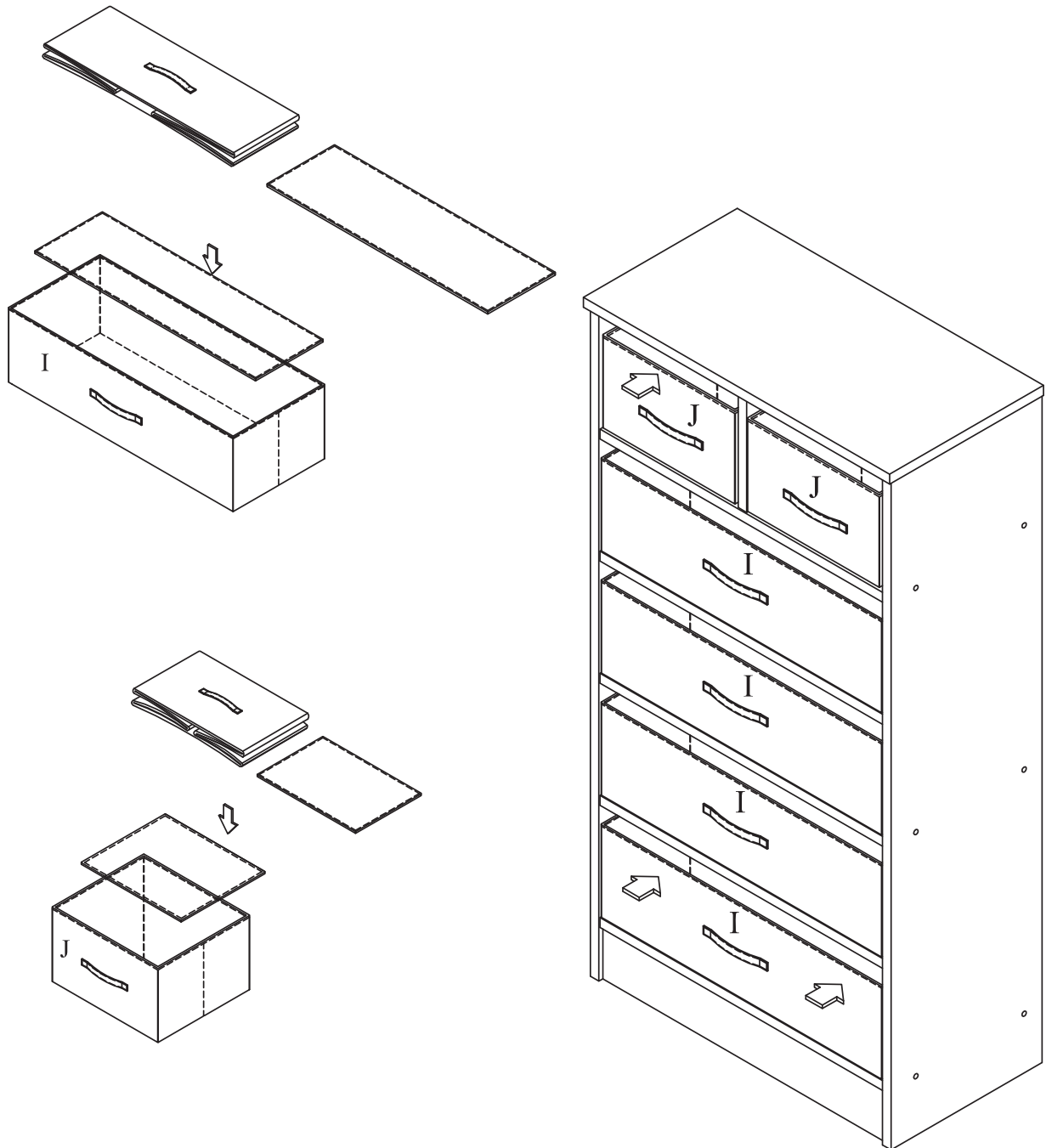

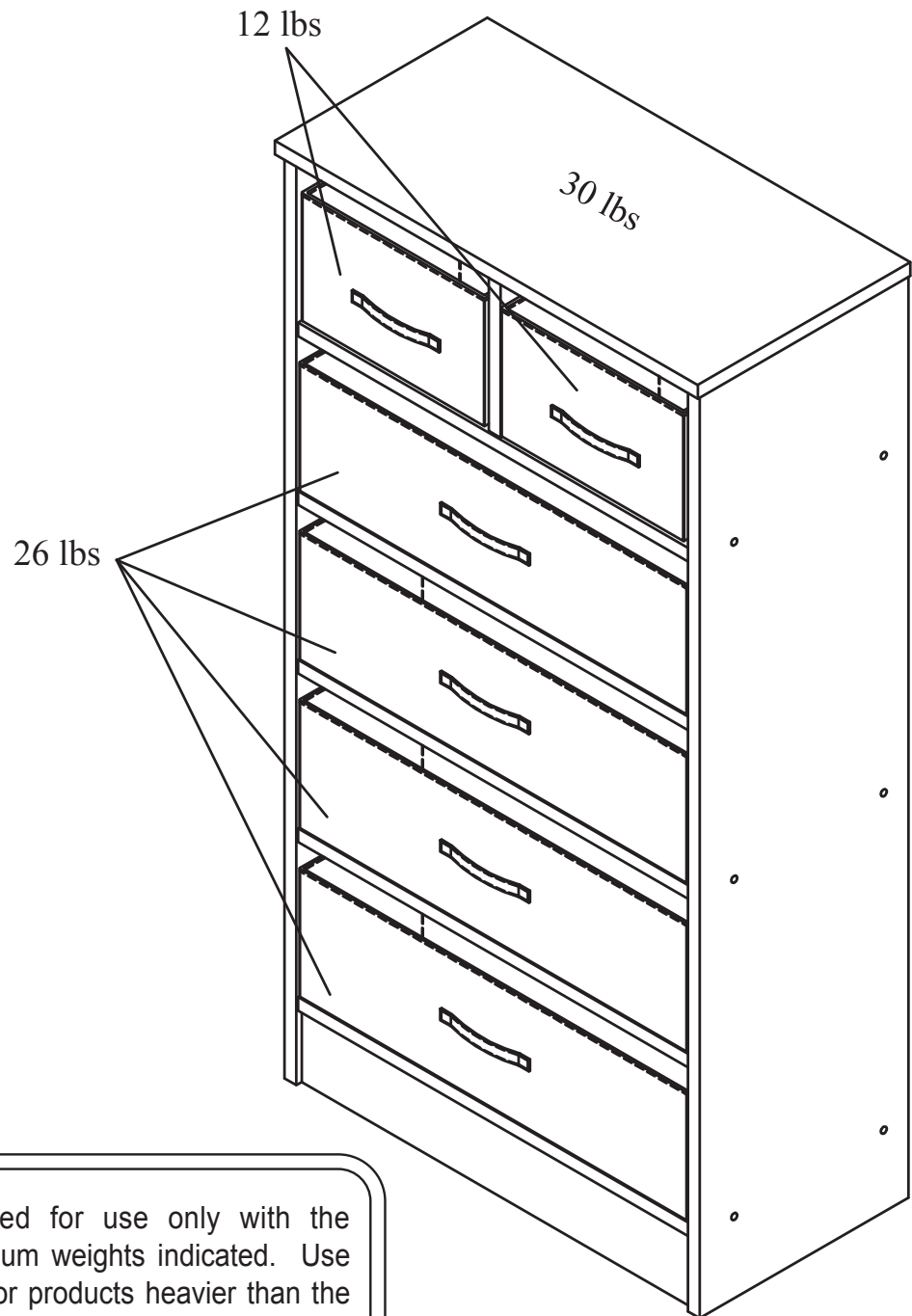

This unit is intended for use only with the products and maximum weights indicated. Use with other products or products heavier than the maximum weights indicated may result in instability causing possible injury. Furniture can tip over or break if improperly moved. Have a friend help to lift and carry the unit to its new location.

Do you have any questions? Missing small parts or hardware?
If you need assistance with the assembly of your
6 DRAWER ORGANIZER
please e-mail our Customer Service Department at:
support@fourstari.com
or call us at (508) 435-4830
or (800) 639-3803

Please include the following information in your email:

- Where item was purchased
- Item, model, style or SKU number listed on instructions or box
- Part number, description of the part and quantity needed

This information will help us get the proper part to you faster