



**Vuescape®**

5.0 MP Digital Camera  
Item Number: 62904200



Installation & User's Guide

All brand names and trademarks are the property of their respective owners.

<b>Contents</b>	
Overview.....	2
System requirements.....	2
Precautions.....	3
Button Outline and Description.....	6
Getting Started.....	8
Load Batteries.....	8
Insert SD/MMC Memory Card (optional).....	8
Power On.....	9
Power Off.....	9
Function Selection Dial.....	9
Taking Pictures.....	10
Description of Flash Function.....	12
Self Timer.....	13
Shoot Mode Menu.....	14
Video Record.....	16
Video Record Mode Menu.....	18
Play Back Photo or Video.....	19
Playback Mode Menu.....	21
Delete Photo/Video File.....	23
Setup Mode.....	23
Connecting to Computer.....	26
Installing the Driver.....	27
Photo and Video Software Operation Instructions.....	31
Operation of Photo Impression.....	35
Operation of Video Impression.....	39
Technical Specifications.....	43
Trouble shooting and FAQ's.....	45
FCC and CE Radiation Norm.....	46
Service Procedure.....	47
Warranty.....	49

## **Overview**

This camera is capable of taking a digital photo at a maximum of 5 mega pixels, and is able to shoot brief AVI videos. The camera is able to automatically adjust exposure and color balance, and it has a 4X digital zoom function. The camera can be used as a PC web camera when connecting with a computer.

The screen display and illustrations contained in the manual are for demonstration purposes on the digital camera. They may differ slightly from your actual digital camera because of the different versions of technical development and production.

## **System Requirements**

To operate and use the digital camera, please refer to the minimum system requirements for the camera application. It is strongly recommended that you use above the minimum computer requirements in order to operate the camera at it's best capability. The minimum system requirements are as follows:

System requirements	
Operating system	Microsoft Windows 98/SE, ME, 2000, XP
CPU	Intel Pentium above or equivalent performance
Memory	128MB and above
Sound card, display card	Sound card and display card support Direct X 8 or higher version
Optical driver	4 X and above
Hard disc	500 MB and above residual space
Other	A standard USB 1.1 interface port

### **Precautions**

- ◆ Please avoid subjecting the camera to dust and chemicals. Please store it in a cool, dry and well ventilated location. Never place it in a location with high temperature, humidity or dust to prevent failure.
- ◆ It is suggested that you test the camera regularly during long periods of storage. Please check to make certain the camera operates normally before use.
- ◆ If dirt or stains accumulate on the camera or lens, it is required to use a piece of soft, clean and dry cloth to wipe it out lightly. Never use rough cloth to wipe. Otherwise, it may scrape the camera or lens surface.
- ◆ If it is required to clean the lens surface, blow away the dust accumulated on the surface, and then use cloth or towel suitable for optical equipment to wipe the lens lightly. If need

- be please use a lens cleaning solution. Never use organic solvent to clean the camera.
- ◆ Never touch the lens surface with finger.
  - ◆ The external SD and MMC card slots are made with precise electronic components. The following conditions may cause the information stored on these cards to be lost or damaged:
    1. Use of the memory card incorrectly.
    2. Memory card is subjected to being bent, dropped or stepped on.
    3. Heat, humidity and direct sunlight.
    4. Static or electromagnetic field around the memory card.
    5. Removing the memory card or unplugging the digital camera power supply when the digital camera or computer is accessing the memory card (i.e. read, write and format, etc.)
    6. Touching the metal contact surface of the card with a finger or metal object.
    7. The memory card has reached the end of its service life (please purchase a new memory card.)
  - ◆ The SD card contains a write protection switch used to prevent the information being deleted by mistake. If the switch is placed in the lock position, the information inside the card will be protected. However, when the card is placed in the Write protection status, it cannot be used for operations such as saving pictures or deleting them.

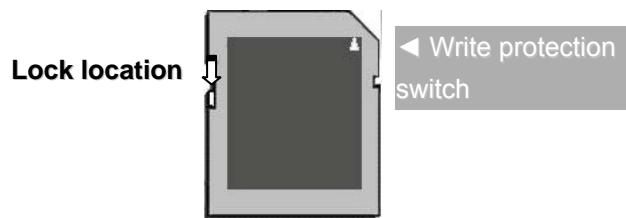

- ◆ It should be noted that when saving a file in the memory or the memory card, the file size should not be larger than the size of the memory.
- ◆ The digital camera will function in temperatures of 0-40° C (32-104° F). Never place the digital camera into an extreme heat environment, such as inside a car parked under heated sun, or in a very damp environment. To avoid the condensation in the digital camera, when it is taken out from a cold place to a warm location, please put the digital camera into a tightly sealed plastic bag, and take it out after the digital camera temperature reaches the indoor temperature.
- ◆ Any television program, movie, music, picture and other resources all may be protected by copyrights, and it may breach the laws concerning copyrights when shooting/using these resources without permission. Please note that the resource subjected to the copyright protection can only be used provided the user complies with the laws concerning copyrights.

**Button Outline and Description**

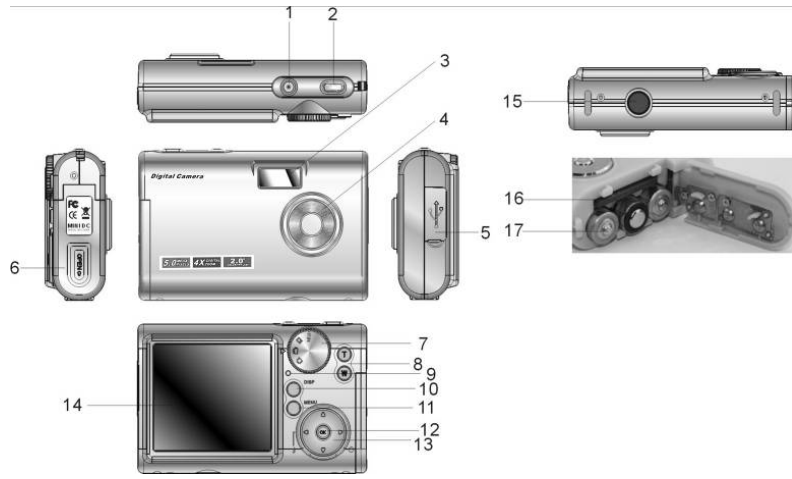

**Function Description for Keys:**

<b>No.</b>	<b>Key</b>	<b>Function description</b>
1	Power	Power On/ Off
2	Shutter	Shoot
3	Flash strobe	Flash pictures
4	Lens	Shoot images
5	USB port	Connection to computer
6	Battery lid	Hold Batteries
7	Mode turntable dial	Photos/Video record/playback/setup
8	Digital zoom key	Tele-zoom in / Wide angle-zoom out
9	Status indicator (LED)	System busy status indicator
10	DISP	Display mode control button
11	MENU	Enter/exit menu button
12	OK	Play/Confirm button
13	Direction key	Select cursor guide/value adjustment
14	Display screen TFT	Display all operating information and pictures
15	Tripod support lug	Connect camera to tripod
16	SD/MMC card slot	For insertion of memory card
17	Battery compartment	Load 3 x AAA batteries

## **Getting Started**

### **Load Batteries:**

The digital camera uses 3 AAA batteries. It is required to turn off the power first when replacing the batteries.

Open the battery compartment lid, and load all batteries, noting the battery positive/negative polarity mark. Then, close the battery compartment lid.

### **Insert SD/MMC Memory Card (optional)**

The camera supports SD and MMC cards. If the camera is loaded with a memory card, the camera's built-in memory is disabled.

Open the battery compartment lid, insert SD/MMC memory card in the correct direction.

To take out a memory card, please open the battery compartment lid first, then press downward on the SD/MMC memory card lightly and the card will pop out automatically.

Note:

- To insert the card, please follow the proper direction as shown by the symbol beside the card slot. Please don't push too hard when inserting the card to prevent damaging the card or camera parts.
- If it is required to remove the memory, the camera's power should be turned off prior to taking out the memory card.

**Power On**

Press the POWER key down and hold for 1 second. The camera will be turned on and the LCD Display will light up.

**Power Off**

Manual power off: Press POWER key and hold for 1 second.

Auto power off: When the camera is not in use for a period of time, the camera will turn off automatically at the time that you can set while in the setup mode in order to save on battery power.

Low power off: When the battery power is low, a low power icon will appear on the LCD display screen as . Several seconds later, the camera will turn off automatically, meaning that it is time to replace the cells with new batteries.

**Function Selection Dial**









Rotate the mode select dial (  ) after turning on the camera to select shoot / video record/playback or setup modes.





### Taking Pictures

- 1 Move the mode turntable dial after booting to enter shoot mode (M).
- 2 Hold the camera steady and press the shutter key to shoot one photo after aiming at a scene.
- 3 Under the preview mode, press the Tele or Wide key to use the digital zoom function (4×), and the right side of LCD is displayed with the zoom level indicator.
- 4 Press the navigation key left button to turn on the flash for shooting.
- 5 When the memory is full and the shutter button is pressed, it will display "Memory full", and no more memory space is available.
- 6 Press the DISP key under the shoot mode preview status to switch between the following modes: normal mode-information, concealed mode or screen saver (energy saving) mode.



Shoot mode preview (normal mode)    Information concealed mode    Screen saver (energy saving) mode



Display Graphics	Description
0007	Number of frames camera is able to take (7 photos) in current mode (estimated value.)
	Camera is set for frequency of 50 Hz at present, selectable frequencies: 50Hz/60Hz
	The photo print date function is on, and the icon will be concealed if you turn off the function.
	The self-timer function is off, selectable for off  / on 
	Flash is cancelled, you may select: forced flash  /auto flash  flash off 

<p><b>0.0EV</b></p>	<p>The present exposure compensation EV is set at 0.0, and in preview mode you can press the direction key Up/Down to adjust the EV from: -1.5EV~+1.5EV, in 0.3EV/steps</p>
<p> <b>2592x1944</b></p>	<p>Image resolution setting, you may select from: 3264×2448; 2592×1944; 2304×1728, 2048×1536; 1600×1200 and 640×480</p>
<p></p>	<p>Battery icon represents the battery power status,  for low battery power, and will activate automatic turning off</p>
<p></p>	<p>SD/MMC card icon displays after you insert a card into the camera.</p>
<p> 10</p>	<p>Self-Timer 10 second count down allows you to get in picture</p>

**Description of Flash Function**

Press Down the direction left key while in the shoot mode preview status to select the flash functions from the following 3 modes:

Flash off--Forced flash--Auto flash

Graphic Display	Description
	Flash Off : Will not allow flash to function
	Forced Flash: Flash will go off for each shot taken
	Auto Flash: A sensor in the camera automatically controls whether to allow flash by measuring the available light present.

When turning on the flash function, the camera will charge the flash automatically and during the charging interval, the status indicator will blink. When the charging is complete (generally 10 sec.), the status indicator will stop blinking and this will indicate you are ready to take the picture.

#### Self-Timer

Press Down the direction right key while in the shoot mode preview status to turn on the self-timer function, and the self-timer icon  will appear at the top of LCD. Press again the shutter key to start the 10 second count down which will allow you to get into the picture. When the counter reaches 0 the camera will shoot one photo automatically. Press the direction key's Right key under the self-timer mode to turn off the self-timer function, and to return back to the normal shoot mode.

#### Precautions:







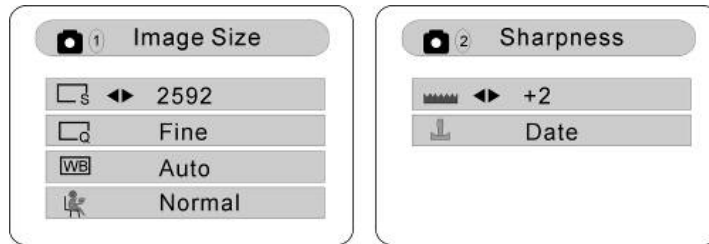

- 1 *When using built-in memory to save the photo, it is required to download the photo or information backup from the camera before turning the power off and removing the battery. Otherwise, the photo or information will be lost due to camera power off; It is suggested to use external memory card (SD/MMC) to save the photo and information.*
- 2 *When using the built-in memory to save a photo, only 2 photos can be taken , A "Memory full" warning will appear after shooting 2 photos.*

### Shoot Mode Menu

- 1 Enter menu: Under the shooting mode preview status, press the MENU key to enter menu mode;
- 2 Press the direction key Up/Down key to select menu, press the direction key Left/Right to enter/exit a submenu or to adjust a parameter;
- 3 Press OK key to confirm the operation;



## Shooting Mode Menu

Graphic display	Description
	Presently camera is set in shoot menu mode
①/②	① Page 1 of menu, ② Page 2 of menu
Image Size	Present resolution will be indicated in the menu title
	Allows you to press the direction key Left or Right to adjust or select menu parameter entry
	Image resolution is selectable: 3264×2448; 2592×1944 (default); 2304×1728, 2048×1536; 1600×1200 and 640×480
	Image quality can be selected as: Fine/ Normal/ Super
	White balance setup : Auto/ manual (Daylight), (Cloudy), (Inca) and (Fluoresce)
	Photo effect available to setup for: Normal/black and white/Sepia/negative
	Photo sharpness, available to setup for: +2/+1/0/-1/-2
	Photo print date, available to setup for: Off/Date/ Date & time

### Video Record



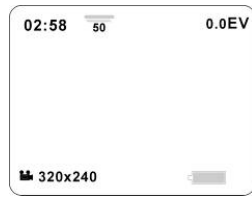

- 1 Rotate the mode select dial to "video record" mode after turning on the camera. (📹)
- 2 Hold the camera steady and press the shutter key to start video recording after aiming at a scene.
- 3 Press the shutter once more to end the video and to save the video record; When the memory is full, it will also terminate the recording automatically.

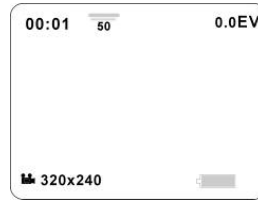

Video preview mode



Video record mode when recording

Graphic display	Description
<b>02: 58</b>	The video record time at present mode is about 2 min. 58 sec. and it will start counting from zero after you press the shutter.
 50	The frequency is set to 50 Hz at present, selectable: 50Hz/60Hz
<b>0.0EV</b>	Present exposure compensation EV is 0.0, for preview mode, you may press the direction key Up/Down to adjust, adjustable range is : -1.5EV to +1.5EV, in 0.3EV steps
 <b>320x240</b>	The image resolution setting, you may select from : 640x480, 320x240 160x112
	Battery icon indicates the current level of battery power. For low battery power a  icon will display and the camera will turn off. Replace batteries.
	SD/MMC card icon will display when these memory cards are in use.





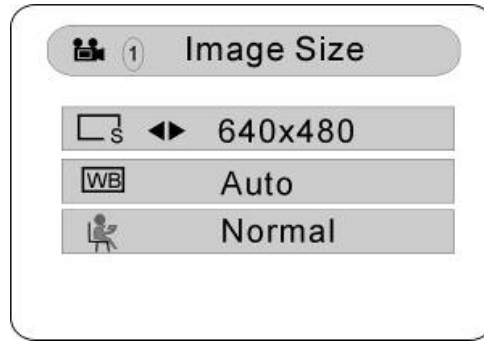

**Precautions**

- 1 When using the built-in memory to save the video, it is required to download the information (backup) from the camera before the low battery icon appears or before power is turned off or removing the battery. Otherwise, the information will be lost due to camera power off; It is suggested to use an external memory card (SD/MMC) to save the information.
- 2 When using the built-in memory to save video, only 2-3s recordings of video can be recorded, "Memory full" will be shown when you attempt to depress the shutter.

### Video Record Mode Menu

- 1 Enter menu: Under the video record mode preview status, press the MENU key to enter menu mode;
- 2 Press the direction key Up/Down key to select menu, and press the direction key Left/Right to adjust a parameter or setup;
- 3 Press OK key to confirm the operation;



Graphic display	Description
	The camera is set in video record menu mode.
	① Page 1 of menu,
Image Size	Present resolution will be indicated in the menu title
	Allows you to press the direction key Left or Right to adjust or select menu parameter entry
	Image resolution is selectable: 640×480, 320×240, 160×112
	White balance setup for: Auto/manual (Daylight), (Cloudy), (Inca) and (Fluoresce)
	Photo effect available to setup for: Normal/black and white/Sepia/negative

#### Playing Back Photos or Videos

- 1 Rotate the mode select dial to the playback mode () after turning the camera on and the camera will play the current photo or video file in thumbnail mode;
- 2 Press the direction key Up/Down or Left/Right key to select other photos or video files and then press the OK button to display them in full screen mode;
- 3 Press the DISP key continuously to change the display mode from full screen to four small pictures or to nine small pictures as shown below;

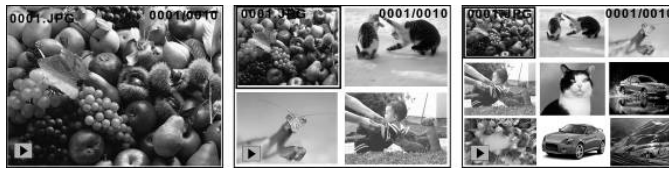

- 4 When searching the recorded video file in full screen mode, it will play the video file automatically, and press OK key to terminate the play while playing the video files.

Graphic display	Description
0001.JPG	Present file name
0001/0010	Present file No./file total No.
	Play mode icon

- 5 Enlarge or reduce the size of a single photo:  
 Play one photo by full screen mode;  
 Press T key to enlarge the photo;  
 Press OK key, the LCD display will show an indicators on the display. Press the direction key Up/Down key or Left/Right key to move the photo in four directions while you crop the picture.  
 Press OK key to exit the mobile photo mode.  
 Press W key to reduce or resume the photo.







The above operation is described in the following pictures:



**Playback Mode Menu**

Press the MENU key in the playback mode to enter the menu as shown in the following picture. Select a menu with the direction key, press MENU key to exit, and press OK key to confirm the operation.



Graphic display	Description
	Playback mode menu
	Press the right button to enter the submenu, and press the left button to return back to the previous menu
	You are looking at Page 1 of the menu.
<b>Delete File</b>	This cursor is indicated in the menu title
	Delete file menu: The submenu has already deleted One/All.
	Lock out a file menu: The submenu has been Locked/Unlocked. Note: The locked file can't be deleted, but can be deleted by format.
	Play slider setup menu: Start/time interval (1/3/5/30s) /repeat (on/off) Note: Press any button can exit sliding
	Photo rotation setup menu: clockwise 90°/ counter clockwise 90°/ counter clockwise 180°

### Delete Photo/Video File

You can Delete your photo and video files using the steps listed below, but before deleting, you should back up important files.

- 1 Delete one: Run "Delete one" menu function in playback mode to delete the present play photo/video file; (Locked files cannot be deleted).
- 2 Delete all: Run "Delete all" menu function in playback mode to delete all the photo/video files; (Locked files cannot be deleted).
- 3 Format: Run "Format" operation (refer to the description below) in the setup mode menu to delete all the files in the memory.

### Setup Mode

- 1 Rotate the mode select dial to the setup mode after turning on the camera (SETUP)
- 2 Press the MENU key to enter setup menu as shown in the following picture:



Select the menu or adjust the parameter with the direction key, and press OK key to confirm operation.

- 1 System clock setup:  
Select "System Time" in the menu and press the direction Left/Right key to enter submenu, and you are able to select SET and Display in the submenu:





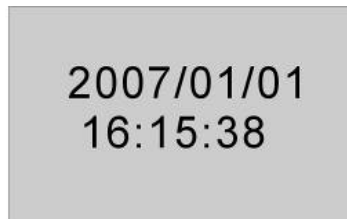



Clock setup



Time clock display

Use the direction Left/Right key to move the cursor in the clock setup menu, and use the Up/Down key to adjust the value. Press OK key to confirm, and press MENU to exit.

- 2  BEEP setup: To setup button tone ON or OFF. When the key tone is ON: Press any key to deliver BEEP sound, and when the button tone is OFF: Press any key to deliver no BEEP sound.
- 3  Power frequency setup: It is able to setup as 50 Hz or the 60 Hz according to the local application.
- 4  Connecting computer mode setup: Movable disc MSDC/PC camera mode PCCAM.

- 5  Sleep time setup: The camera will turn off the power automatically and enter the energy saving mode after a certain camera standby time (not pressing any key). It is available to select among 30s/60s/3min/5min/never sleep. (For video recording or record play back and slide show play back , no sleep operation is given.)
- 6  Counter setup: The camera will count the picture number or number of times automatically when shooting or video recording. It is able to setup Up/Down counting. The Up counting is an adding mode, and the Down counting is a reducing mode.
- 7  Clock system setup: It is able to setup for 12 hours/24 hours system according to the requirement.
- 8  Default setup: Resumes all the default setups as programmed in the factory when running the function.
- 9  Format: Will format all data in the memory or memory card. WARNING! After running the Format function, all data in the memory or memory card will all be deleted.

### Connecting to a Computer

Install the included CD software driver first before connecting the camera to the computer.

Turn on the camera power, and if it is required to use the camera video head function, please setup the camera USB mode to PC Cam mode; If it is required to use the camera removable disc function, please setup camera to MSDC mode.

The USB line 4PIN terminal is connected to the USB port of a computer, and the other terminal (5 PIN) is connected to the USB port of the camera.

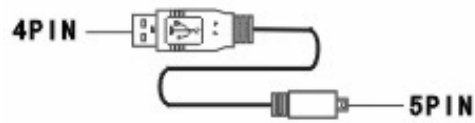

How to download a file to computer from the camera:

There will be two removable disc icons in the "My computer" window while using the removable disc function of the camera. The 1<sup>st</sup> removable disc is corresponding to the SD/MMC card (if no card is inserted in the camera, this feature will not be accessible) plugged into the camera, the second removable disc is corresponding to the memory inside camera. The photo and video files you made are saved in \DCIM\100MEDIA file folder inside the removable disc. Select photo/video record file inside the "100MEDIA" file folder, duplicate (or click on and mouse drag) the file to the file folder you want to save in the computer hard disc.

Note:

- Do not operate the camera when connecting it to the computer to prevent losing your data.
- Confirm that the USB mode has already been setup to "MSDC" for the camera playback mode first before using the removable disc function of the camera, otherwise you can not use the function normally.

### **Installing the Driver**

Driver program

You can use and operate the removable disc function and PC Camera provided by the digital camera through your PC. Please install the software driver program according to the following steps before connecting the camera.

Note: Do not connect the camera to the computer USB port before you install the driver to the computer to prevent driver installation errors.

### **Software installation interface**

1. Please load the installation CD into your computer's CD-Rom drive.
2. The system will run the installation program CD automatically, and the screen will present the following window as shown below:





- (If your optical drive has no auto execution or close auto execution function, please browse the CD and run the autorun.exe program located at the CD root directory.)
- For Windows Vista, the following window will pop up when the system automatically executes the installer in the CD. Please click  to continue.

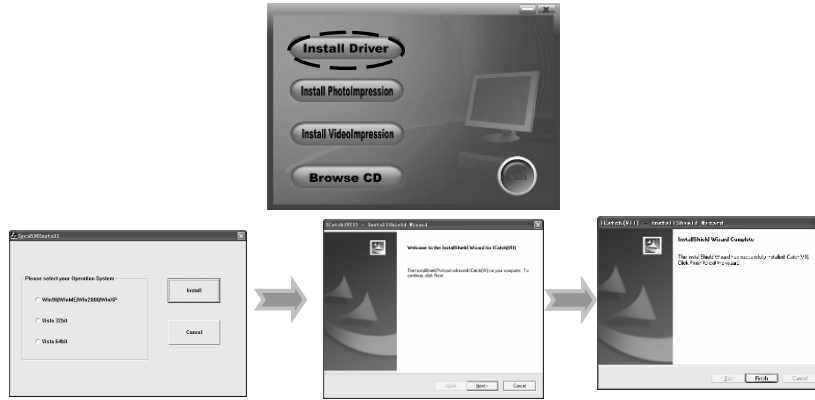

### Driver installation

Click the "Driver" button, and complete the installation as per the wizard. Then, reboot the computer.



**Note:** For Windows Vista, the following window will pop up when installing the software. Please click  to continue.

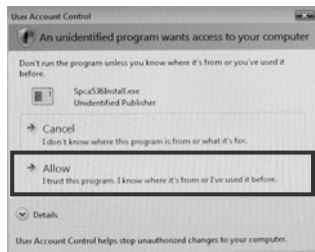

Please restart the PC after installation.

The driver program will support the operating systems of Windows 98SE/2000/ME/XP/Vista. If the following window appears, please click the "Yes" button to go on with the installation.

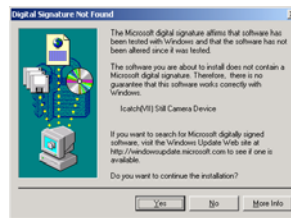

**Hint:** In Windows 98SE operation system, if it is needed to play the video record, please install Video Impression first. With the help of the DirectX9 module in the Video Impression software, the video shot by the camera will be successfully played on the computer.

### **Photo and Video Software Operating Instructions**

The software Photo Impression and Video Impression are included in the package. They are used for video and image processing purpose.

#### **Software installation**

1. Please put the installation CD into the CD-ROM of the computer;
2. The system will execute the installation procedure in the CD automatically and the screen will display the following windows:



Click the **Install PhotoImpression** button and complete the installation of Photo Impression according to the instructions.

Note: For Windows Vista, the following windows will pop up when installing the software. Please click **Continue** to continue.

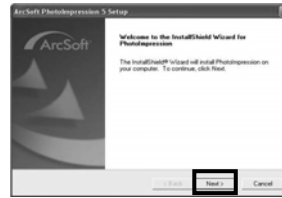
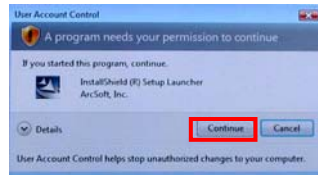

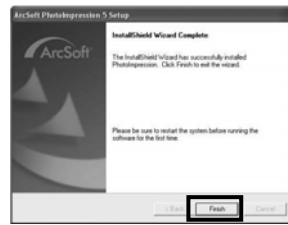

- Click the **Install VideoImpression** button and complete the installation of Video Impression according to the instructions.

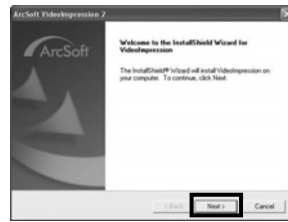

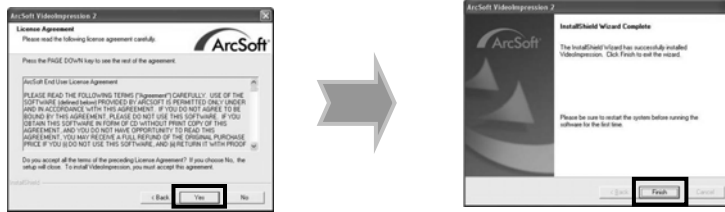

Please restart your PC after installation.

**Note:**

1. In case of no image, please check whether the driver for the camera is installed securely, and check whether the selected device in the window is:



2. For detailed information of Video Impression 2, please refer to the part "Installation and Operation of Video Impression".

## Operation of Photo Impression

Double-click the  icon on the desktop, or run Photo Impression 5 in “Start→Programs”.

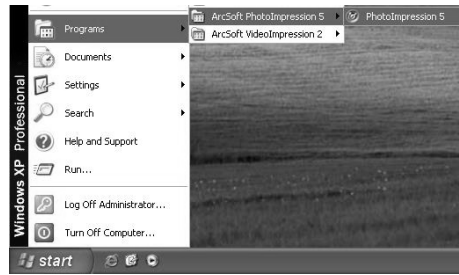

The following window will pop up when opening Photo Impression5. Please left-click the center of the window to close it. Photo Impression can be opened after the window is closed.



After opening the PhotoImpression, "Get Photo" window will appear.



Select the desired image from “Get Photo” window, and you will find the image is displayed at the central area of the window. After that, you can select the image to edit.

Detailed operation method of Photo Impression can be referred to in the "Help" section of the program (as shown in the following figure).

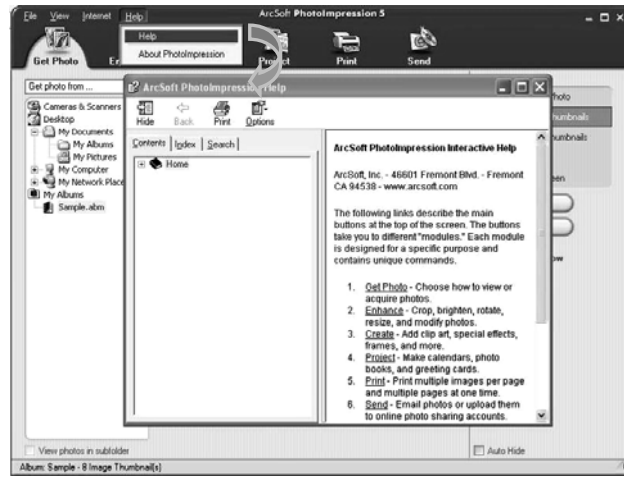

## Operation of Video Impression



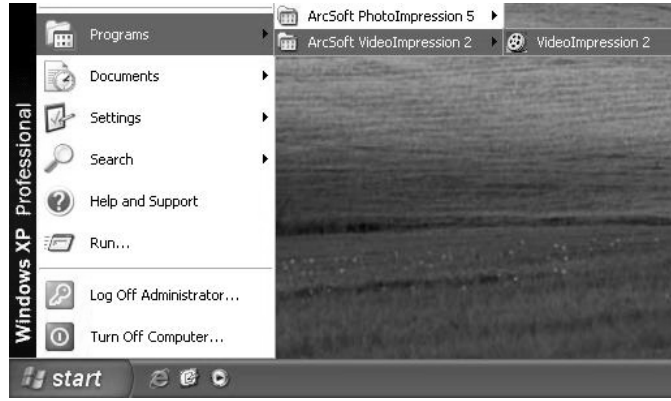

Double-click the **Video Impression 2** icon on the desktop, or open Video Impression 2 in “Start → Programs”.



Detailed operation method of Video Impression 2 can be referred to in the “Help” section of the program (as shown in the following figure).



## Using the PC Camera function in Video Impression 2:

Connect the camera in PC Camera mode to your PC and open Video Impression 2. Click  in "Wizard" (Fig. 1) and click  (Fig. 2); or click  button in "MEDIA" (Fig. 3) tab. Live window as Fig. 4 shown will appear.



▲ Fig. 1

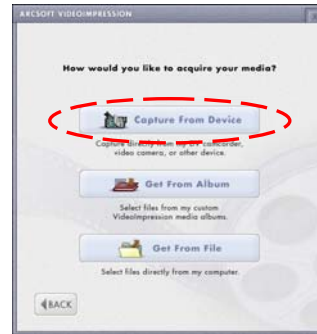

▲ Fig. 2



▲ Fig. 3

Click  button to exit after use.

Note: In case of no image, please check whether the driver for the camera is installed securely, and check whether the selected device in the window is:



For detailed information of Video Impression 2, please refer to the part "Installation and Operation of Video Impression 2".



▲ Fig. 4

**Technical Specifications**

Image sensor	5 million pixel element sensor
Function modes	Photo, Short Video, Playback, Setup
Lens	F2.8 f=10.8mm
Focal distance	5.2ft ~infinity (standard mode)
Digital zoom	4×
Shutter	Electronic shutter
LCD display screen	2.0" TFT LCD
Picture resolution	3264x2448, 2592x1944, 2304x1728, 2048x1536, 1600x1200 and 640x480
Video record resolution	QVGA: 640x480(10fps), QVGA: 320x240(15~20fps) 160x112(30fps)
White balance	Auto/manual, Daylight, Cloudy, Inca and Fluorescent
Exposure	Automatic/manual (-1.5EV~+1.5EV, 0.3EV/step)

Flash mode	Auto/forced/Off	
Self-shoot timer	10 seconds delay	
File format	Video	AVI
	Photo	JPEG
Memory medium	Built-in SDRAM (8MB), SD/MMC card (maximum support 1GB)	
Display screen	640X240 Picture element, 2.0 inches	
USB interface	Mini USB1.1Interface	
Power supply	Battery: 3×AAA	
Dimensions (L×W×H)	87.8x23.3x56.2 mm	
Weight	Not including battery: 71 grams	

**Packing list:**

User Guide x1  
Installation CD x1  
USB cable x1  
Pouch x1

### **Trouble Shooting and FAQ's**

Camera won't turn on after loading battery	The batteries may not be fresh. Please replace with new batteries.
	The battery plastic package has not yet been removed completely.
	The battery placement may be in the wrong direction, pls check it
Press the shutter key but not able to shoot or video record	The memory or SD/MMC memory card is full, and please save to computer or delete some files to make new space.
The photo and video files in the camera memory can't be played back.	SD/MMC memory card is inserted in the camera, and the camera memory is disabled. Please turn the power off and takeout the memory card.
The photo is not clear.	The camera focus distance is too close , please adjust it.
	Please hold the camera steady with both hands, or place the camera on a tripod. Don't shake or move the camera while shooting.
The photo or video record is obscure.	The shooting/recording light is not sufficient. Please shoot/record in a location with sufficient light. Or use flash for a dark environment when shooting/recording.
Can't play video record on the computer.	Please install DirectX9 and Windows Media Player9 (or higher version) player.
Photo using flash is darker.	The flash distance is too far. Please shoot with flash within 6 feet.

### **FCC and CE Radiation Norm**

#### **FCC**

This equipment has been tested and complies with limits for Class B digital devices pursuant to Part 15 of Federal Communications Commission (FCC) rules.

#### **CE**

This equipment has been tested and complies with the limits of the European Council Directive on the approximation of the law of the member states relating to electromagnetic compatibility (89/336/EEC) according to EN 55022 Class B.

### **FCC and CE Compliance Statement**

These limits are designed to provide reasonable protection against frequency interference in residential installations. This equipment generates, and radiates radio frequency energy, and if not installed properly or used in accordance with the instructions, may cause harmful interference to radio communication. However, there is no guarantee that interference will not occur in television reception, which can be determined by turning the equipment on and off. Interference may be corrected by one or more of the following measures:

- Reorient or relocate the receiving antenna
- Increase the separation between the equipment and the receiver
- Plug the equipment into an outlet on a circuit different from that to which the receiver is connected.



**CAUTION!**

The Federal Communications Commission warns the user that changes or modifications to the unit not expressly approved by the party responsible for compliance could void the user's authority to operate the equipment.

**Customer Service**

**For information regarding the return or exchange of this item within 14 days of purchase , please visit your Inkstop store location or go to [www.inkstop.net](http://www.inkstop.net) to read the instructions regarding customer service returns procedures. Click on the Satisfaction Guaranteed icon on the website.**

For technical support in regards to operation and installation of this item please call the toll free number below to obtain assistance. A customer service representative will assist you and provide operating information on the product.

Please have the following information available when you contact technical support:

- Your Name and Address
- Date of Purchase
- Model Number
- Serial Number
- Store Name and Address
- Type of problem with the unit

To contact the technical support facility, please call **508-435-4830** or 800-639-3803.

Email Support: [techsupport@fourstari.com](mailto:techsupport@fourstari.com)

## **Warranty**

### **90 Days Limited Warranty**

This product is warranted to be free from defects in material and workmanship for a period of 90 days. Warranty obligations are limited to replacement or repair of defective parts and components, at the option of the manufacturer. If the original model is no longer available, we will substitute with a model of equal or better value than the original item. The warranty of this product is null and void if the product is subjected to negligence, abuse, modification, misuse, accident or if the customer uses the product for a function it was not intended for. This warranty is only valid for the original purchaser of this product and will not be honored if the product is resold. This warranty gives you specific legal rights, and you may also have other rights which vary from state to state.

The manufacturer will not be liable for incidental or consequential damages caused by the use of this product. The manufacturer will not be liable for any costs such as lost profits or revenues, cost of temporary replacements, loss of data, loss of equipment or use of equipment or any claims by third parties.

After 14 days from the purchase date of this product, please call the phone number listed below to obtain service. A customer service representative will give you a return authorization (RA number) allowing you to ship the product to the service center. The purchaser must have a copy of the original receipt for proof of purchase within 90 days. The purchaser of this product is responsible for any shipping charges to the repair facility. The manufacturer service center will repair or replace the unit in question and send it back to the purchaser.

In order to contact the service facility, please call 508-435-4830 or 800-639-3803.

The address for this facility is:  
Fourstar Group  
26840 Fargo Ave.  
Suite C  
Bedford Heights, OH 44146

E-mail Support: [techsupport@fourstari.com](mailto:techsupport@fourstari.com)

